

# Norfolk Boreas Offshore Wind Farm Outline Traffic Management Plan Appendices

Part 1 of 2  
(Version 5)

**DCO Document 8.8**

Applicant: Norfolk Boreas Limited  
Document Reference: 8.8  
Deadline 10  
Date: May 2020  
Revision: Version 5  
Author: Royal HaskoningDHV

*Photo: Ormonde Offshore Wind Farm*

## 8 APPENDIX 1 SCENARIO 1 HGV DISTRIBUTION

---

Link ID	Link description	Norfolk Boreas Scenario 1 Construction Vehicle Movements	
		All Vehicles	HGVs
1a	A47	124	100
1b	A47	172	100
2	A47	181	70
3	A47	121	70
4	A47	81	70
5	A47	290	281
6	A47	284	281
7	A47	83	70
8	A146	77	70
9	A47	326	323
10	A47	324	323
11	A1065	10	0
12	A1065	5	0
13a	A148	336	323
13b	A148	215	206
14	A148	150	138
15	B1145 – Litcham	3	0
16	B1110/B1146 - Holt Road	91	64
17	B1145 - Billingford Road	73	64
18	A1067	136	117
19	A148	335	323
20	Mill Common Road	0	0
21	B1147 - Etling Green	38	29
22	B1147 - Dereham Road	58	29
23	Northgate - from junction with B1146	104	64
24	A1067	211	167
25	Elsing Lane	50	30
26	A1074	31	0
27	A140	29	0
28	A140	29	0
29	A1067	164	117
30	A1067	147	117
31	A1067	21	0

Link ID	Link description	Norfolk Boreas Scenario 1 Construction Vehicle Movements	
		All Vehicles	HGVs
32	B1149 – Norwich road	103	92
33	B1149 - Holt Road	152	99
34	B1145 - west of Cawston	130	61
35a	B1159 - Coast Road	118	95
35b	B1159 - Coast Road	118	95
36	B1149 - Holt Road	22	**0
37	B1145 - Cawston road	113	***92
38	A140 - Cromer Road	66	0
39	A140 – Hevingham	220	***138
40a	A140 – Roughton	93	92
40b	A140 – Roughton	287	197
41	B1436 – Felbrigg	145	138
42	B1145 - Reepham Road	80	40
43	Cromer Road - Ingworth	10	0
44a	A149	104	92
44b	A149	127	92
45	A149	76	66
46	B1145 - Lyngate Road	110	67
47a	Bacton Road – North Walsham	24	0
47b	North Walsham Road - Edingthorpe Green	54	30
47c	North Walsham Road – Broomholm	37	30
48	B1159 - Bacton Road	0	0
49	B1159	33	30
50	A1151	14	0
51	A1151	15	0
52	A149 - Wayford Road	89	66
53	A149	281	281
54	A149	93	92
55	A149	93	92
56	A149	97	92
57	A149	97	92
58	NNDR - Link a	237	231
59	NNDR - Link b	231	231

Link ID	Link description	Norfolk Boreas Scenario 1 Construction Vehicle Movements	
		All Vehicles	HGVs
60	NNDR - Link c	117	117
61	B1436 - Roughton Road	20	0
62	A1042	35	0
63	A1151	5	0
64	A12	72	70
65	A47	323	323
66	Wendling – Dereham Road	109	69
67	North Walsham Road / Happisburgh Road	104	64
68	The Street / Heydon Road	105	65
69	Little London Road	81	*61
70	Plantation Road	50	30
71	Vicarage Road / Whimpwell Street	51	31
72	Dereham Road / Longham Road – Dillington	54	34
73	Hoe Road South	49	29
74	Mill Street, Elsing Road – Swanton Morley	50	30
75	B1354 – Blickling	110	70
76	High Noon Road / Church Road	51	31
77	Hall Lane – North Walsham	50	30
78	Bylaugh	50	30
79	B1145 / Suffield Road	75	31
A	Dale Road	54	34
B	Bradenham Lane	109	69
C	Norwich Road	49	29
D	Lime Kiln Road (west)	54	34
E	Mill Lane	54	34
F	Heydon Road	49	29
G	B1145 - Cawston road	52	32
H	Wood Dalling Road	52	32
I	Southgate (Road to Southgate from B1149)	49	29
J	Banningham Road	54	34
K	Greens Road, B1145, Felmingham Road, Brick Kiln Lane	69	37
L	Paston Road	50	30

Link ID	Link description	Norfolk Boreas Scenario 1 Construction Vehicle Movements	
		All Vehicles	HGVs
M	North Walsham Road / Happisburgh Road	53	33
N	Bacton Road	53	33
O	Edingthorpe Road	53	33
P	Edingthorpe	53	33
Q	Hole House Road	53	33
R	North Walsham Road, Grub Street	51	31
S	Walcott Green	51	31
T	Unnamed Road	54	34
U	Swanton Road	49	29
V	Lime Kiln Road	54	34
*	Proposed mitigation flows identified in the ES		
**	Proposed mitigation flows identified in the Norfolk Vanguard OTMP as of Examination Deadline 8 (30 <sup>th</sup> May 2019)		
***	Proposed additional flows bypassing Link 36 (Horsford) due to alternative route identified using Link 37 and Link 39.		

## 9 APPENDIX 2 SCENARIO 2 HGV DISTRIBUTION

---

Link ID	Link description	Norfolk Boreas Scenario 2 Construction Vehicle Movements	
		All Vehicles	HGVs
1a	A47	551	415
1b	A47	785	415
2	A47	691	291
3	A47	525	291
4	A47	369	291
5	A47	641	580
6	A47	604	580
7	A47	358	291
8	A146	322	291
9	A47	648	637
10	A47	640	637
11	A1065	72	0
12	A1065	38	0
13a	A148	683	595
13b	A148	434	*379
14	A148	444	369
15	B1145 – Litcham	15	0
16	B1110/B1146 - Holt Road	352	224
17	B1145 - Billingford Road	320	224
18	A1067	388	313
19	A148	678	637
20	Mill Common Road	0	0
21	B1147 - Etling Green	288	224
22	B1147 - Dereham Road	312	224
23	Northgate - from junction with B1146	4	0
24	A1067	578	407
25	Elsing Lane	92	72
26	A1074	118	0
27	A140	128	0
28	A140	152	0
29	A1067	451	313
30	A1067	457	313
31	A1067	127	0



Link ID	Link description	Norfolk Boreas Scenario 2 Construction Vehicle Movements	
		All Vehicles	HGVs
32	B1149 – Norwich road	257	***184
33	B1149 - Holt Road	385	212
34	B1145 - west of Cawston	276	***112
35a	B1159 - Coast Road	390	294
35b	B1159 - Coast Road	326	263
36	B1149 - Holt Road	136	***0
37	B1145 - Cawston road	366	****264
38	A140 - Cromer Road	292	0
39	A140 – Hevingham	601	****313
40a	A140 – Roughton	300	289
40b	A140 – Roughton	428	184
41	B1436 – Felbrigg	354	*287
42	B1145 - Reepham Road	198	**72
43	Cromer Road - Ingworth	26	0
44a	A149	391	289
44b	A149	420	262
45	A149	320	206
46	B1145 - Lyngate Road	465	224
47a	Bacton Road – North Walsham	145	0
47b	North Walsham Road - Edingthorpe Green	203	72
47c	North Walsham Road – Broomholm	91	**72
48	B1159 - Bacton Road	0	0
49	B1159	91	**72
50	A1151	158	0
51	A1151	88	0
52	A149 - Wayford Road	297	206
53	A149	634	630
54	A149	251	248
55	A149	251	248
56	A149	270	248
57	A149	271	248
58	NNDR - Link a	487	453
59	NNDR - Link b	472	453

Link ID	Link description	Norfolk Boreas Scenario 2 Construction Vehicle Movements	
		All Vehicles	HGVs
60	NNDR - Link c	400	313
61	B1436 - Roughton Road	76	0
62	A1042	164	0
63	A1151	67	0
64	A12	299	291
65	A47	639	637
66	Wendling – Dereham Road	192	152
67	North Walsham Road / Happisburgh Road	159	80
68	The Street / Heydon Road	160	^80
69	Little London Road	260	**48
70	Plantation Road	284	184
71	Vicarage Road / Whimpwell Street	64	30
72	Dereham Road / Longham Road – Dillington	184	136
73	Hoe Road South	158	96
74	Mill Street, Elsing Road – Swanton Morley	103	72
75	B1354 – Blickling	92	72
76	High Noon Road / Church Road	92	72
77	Hall Lane – North Walsham	92	**72
78	Bylaugh	92	72
79	B1145 / Suffield Road	92	72
*	Refined Primary Peak flows identified in the ES		
**	Proposed mitigation flows identified in the ES		
***	Proposed mitigation flows identified in the Norfolk Vanguard OTMP as of Examination Deadline 8 (30 <sup>th</sup> May 2019)		
****	Proposed additional flows bypassing Link 36 (Horsford) due to alternative route identified using Link 37 and Link 39.		
^	Includes up to 10 movements to the Cable Logistics Area during cable pulling works		

## 10 APPENDIX 3 ROUTE ACCESS STUDY

---

# COLLETT

EXPERTS IN MOTION



Route Access Survey – Revision 2  
314597

Norfolk Vanguard  
Off A47 near Necton, Norfolk

Royal HaskoningDHV

Report Produced: March 2018

## Contents

REPORT DETAILS.....	3
NON-DISCLOSURE NOTICE.....	3
THIRD PARTY DISCLAIMER.....	3
COMPANY PROFILE.....	4
1 EXECUTIVE SUMMARY.....	5
2. INTRODUCTION.....	6
3. COMPONENTS.....	7
4. ABNORMAL INDIVISIBLE LOAD PROFILES.....	7
5. REQUIREMENTS FOR THE MOVEMENT OF ABNORMAL INDIVISIBLE LOADS.....	8
6. PORT INFORMATION.....	10
7. RESPONSES FROM STATUTORY CONSULTEES (STRUCTURES SUITABILITY).....	11
8. ROUTE ASSESSMENT.....	12
9. RECOMMENDATIONS.....	37
10. IMPORTANT NOTES.....	38
11. LIST OF DRAWING NUMBERS.....	39
APPENDIX 1 - ELEVATION DRAWINGS OF SWEEP PATH MODELS	
APPENDIX 2 – SWEEP PATH ANALYSIS	
APPENDIX 3 - COUNCIL CORRESPONDENCE AND COMMENTS	

## Report Details

### Report for

Ryan Eldon  
 Royal HaskoningDHV  
 Rightwell House  
 Bretton  
 Peterborough  
 PE3 8DW

### Attendees of Survey

Steven Mangham

### Issued by

Steven Mangham

### Approved by

Steven Mangham

Collett & Sons Ltd  
 Victoria Terminal  
 Albert Road  
 Halifax  
 West Yorkshire  
 HX2 0DF  
 Tel: +44 (0) 8456 255288  
 Fax: +44 (0) 8456 255244

### Document Revisions

No	Date	Details
1	25/04/2018	Route B removed from report
2	25/04/2018	Updated to Client Comments

## Non-Disclosure Notice

The methodology contained in this report is provided to you in confidence and must not be disclosed or copied to third parties without the prior written agreement of Collett & Sons Limited. Disclosure of that information may constitute an actionable breach of confidence or may otherwise prejudice our commercial interests. Any third party who obtains access to this report by any means will, in any event, be subject to the Third Party Disclaimer set out below.

## Third Party Disclaimer

Any disclosure of this report to a third party is subject to this disclaimer. The report was prepared by Collett & Sons Limited at the instruction of, and for use by, our client named on the front of the report. It does not in any way constitute advice to any third party who is able to access it by any means. Collett & Sons Limited excludes to the fullest extent lawfully permitted all liability whatsoever for any loss or damage howsoever arising from reliance on the contents of this report. We do not however exclude our liability (if any) for personal injury or death resulting from our negligence, for fraud or any other matter in relation to which we cannot legally exclude liability.

## Company Profile

Collett & Sons Ltd established in Halifax over 45 years ago specialise in the multimodal logistics throughout the UK, Europe and Worldwide.

Our Company owns a modern fleet of over 60 vehicles and over 100 trailers, operating from 3 depots located in Halifax, Goole and Grangemouth.

The depots situated in Google and Grangemouth offer strategically located sites suitable to provide central hubs for the distribution of abnormal load components throughout the UK. Each facility is complete with up to 110 tonnes lifting capacity in order to be able to handle different abnormal load types. As logistical partners to the Wind Energy Industry, the company is able to offer the complete transport solution from point of manufacture through to job site.

Collett & Sons Limited operate an in-house consultancy that deals with transport feasibility, route and site access surveys, Swept Path Analysis, Traffic Management Plans, Test Drives and Environment Statements.

In addition to consulting services, Collett & Sons Limited delivers the following services;

- Marine
- Port Operation
- Heavy Lift Storage
- Heavy Transport
- Project Management
- Freight Forwarding
- Heavy Lift
- General Haulage
- Warehousing
- Test Station (DVSA-authorized)
- SHEQ Training



Collett & Sons Ltd  
Victoria Terminal  
Albert Road  
Halifax  
West Yorkshire  
HX2 0DF

+44 (0) 8456 255288  
renewables@collett.co.uk  
www.collett.co.uk

## **1 Executive Summary**

- 1.1. One route has been assessed for the transportation of a 200Te Transformer from the Kings Lynn Port to proposed Norfolk Vanguard Site. The Route has been detailed along the A47 to site.
- 1.2. The start location within the Port of Kings Lynn has been chosen due to previous information regarding the heavy load quay within the dock.

### ***Third party land***

- 1.3. No third party land has been identified by the assessment.

### ***Road widening***

- 1.4. No road widening has been identified by the assessment.

### ***Modifications to street furniture***

- 1.5. Street furniture removal will be required at a number of locations along the route and have been detailed where required.

### ***Manual Steering***

- 1.6. Due to the vehicle configuration, manual steering will be utilised at numerous locations along the routes including roundabouts.

### ***Vertical Alignment***

- 1.7. There is an overhead bridge along Route A on the A47. Clarification of the bridge clearance height has been sought from the relevant authorities and the response has indicated a clearance of 5.18m critical. Additional clearance checks to be undertaken prior to any movements.

### ***Structural Assessment***

- 1.8. The relevant authorities who own or manage the structures on the route have been consulted regarding any potential issues along the proposed route. No negative responses have been received at time of issue although Kier Group, who manages the A47, would not comment without a formal BE16 being applied for.

### ***Other areas of note***

- 1.9. There are numerous overhead cables along both routes. Once the final loaded configuration and dimensions are finalised, the utilities services should be contacted regarding their cable heights. It may be that some cables will have to be removed or a specialist team join the delivery convoy to raise the cables, where required.
- 1.10. Tree pruning will be required along the route to ensure a suitable clearance is available for the load.



## 2. Introduction

- 2.1 Collett & Sons Ltd. were commissioned by Royal Haskoning DHV (RHDHV) to undertake an abnormal loads route access study to assess the transportation of a 200Te Transformer to the Norfolk Vanguard Site, off A47 near Necton, Norfolk (the site).
- 2.2 The site is located off the A47 near Necton, Norfolk. The purpose of this report is to detail access to the entrance of Norfolk Vanguard site from Kings Lynn Harbour.

## Methodology

- 2.3 An initial desk based study was undertaken to identify possible loading configurations for the component (details confirmed by RHDHV).
- 2.4 The route surveyed in this report has been identified by Collett.
- 2.5 A site visit was then carried out to determine the feasibility of the identified routes and pinch points.
- 2.6 Following the site visit, Swept Path Analysis (SPA) was then carried out at the identified pinch points. The SPA's are detailed in this report, and indicate any areas of road widening or land take that are required.
- 2.7 All drawings are produced using Ordnance Survey 'OS MasterMap' mapping data, unless stated otherwise. Street furniture is not included on OS MasterMap data; this is plotted by taking measurements on site with a tape. Actual road widths are also checked and adjusted on the map data accordingly. Where adjustments to the OS MasterMap data have been made this is indicated as 'adjusted' on the drawing.
- 2.8 The analysis is based on the most onerous components when loaded on delivery vehicles.
- 2.9 The trailers used to transport the component modular. Manual Steering indicates that the steering of the axles is controlled by an operative using an override device. Manual Steering can be used to achieve alternative swept areas where appropriate.
- 2.10 Upon selection of the route, the relevant authorities were contacted with regard to the structural suitability of the delivery route for the heaviest loaded vehicle.
- 2.11 Details pertaining to the highway boundary have not been obtained from the County Council, thus in order to determine the impact on third party land it has been assumed that fence lines, walls and hedgerows define this boundary.
- 2.12 In addition, the report is supplemented by photographic evidence, map referencing and CAD drawings of the 'pinch points' for the proposed routes.

### 3. Components

- 3.1. RHDHV have requested that the assessment on which this report is compiled be based on the delivery of a 200Te Transformer.
- 3.2. The transformer specification was supplied by RHDHV.

### 4. Abnormal Indivisible Load Profiles

- 4.1. The abnormal loads are assessed based on weight, length, width and height and loaded to the most appropriate vehicle, the weights and dimensions of these are detailed below. The loading diagrams are detailed in APPENDIX 1.

4.2.	314597-A
200te Transformer	
	Loaded vehicle dimensions
Overall vehicle Length	66.06m
Rigid Length	27.04m
Width	4.929m
Height	5.10
G.V.W excluding tractor units	332.86Te

## 5. Requirements for the movement of Abnormal Indivisible Loads

5.1. An abnormal load is defined as below (including the actions required for permitting and notice).

### Weight

- 5.2. Gross weight or axle weights exceeding C & U or Authorised Weight limits up to 80,000kgs (78.74 tons).
- 5.3. **Action required:** 2 clear days' notice with indemnity to Highway and Bridge Authorities.
- 5.4. Gross weight (of vehicle carrying the load) exceeding 80,000kgs (78.74tons) up to 150,000kgs (147.63tons).
- 5.5. **Action required:** 2 clear days' notice to Police and 5 clear days' notice with indemnity to Highway and Bridge Authorities.
- 5.6. Gross weight (of vehicle carrying the load) exceeding 150,000kgs (147.63tons).
- 5.7. **Action required:** HA Special Order (form BE16), up to 8 weeks approval time, plus 5 clear days' notice to Police and 5 clear days' notice with indemnity to Highway and Bridge Authorities.

### Width

- 5.8. Width exceeding 2.9 metres (for C & U loads) 3.0 metres (9' 10") up to 5.0 metres (16' 5") for other loads
- 5.9. **Action required:** 2 clear days' notice to the Police.
- 5.10. Width exceeding 5.0 metres (16' 5") up to 6.1metres (20')
- 5.11. **Action required:** HA form VR1 plus 2 clear days' notice to Police.
- 5.12. Width exceeding 6.1 metres (20')
- 5.13. **Action required:** HA Special Order (form BE16), up to 8 weeks approval time, plus 5 clear days' notice to Police and 5 clear days' notice with indemnity to Highway and Bridge Authorities.

### Length

- 5.14. When exceeding 18.65 metres (61' 2") up to 30 metres (98' 5") rigid length - (Vehicle or train of vehicles)
- 5.15. **Action required:** 2 clear days' notice to the Police.
- 5.16. Vehicle combination exceeding 25.9 metres (85').
- 5.17. **Action required:** 2 clear days' notice to the Police.
- 5.18. When exceeding 30.0 metres (98' 5") rigid length.
- 5.19. **Action required:** HA Special Order (form BE 16), up to 8 weeks approval time, plus 5 clear days' notice to Police and 5 clear days' notice with indemnity to Highway and Bridge Authorities.

### Bridge Height

- 5.20. Any low bridges along the route that have a clearance less than 5.0m will be signed as a low bridge. This threshold could create difficulties in the passage of over-height or near over-height vehicles.

**Abnormal Load Requirements**

5.21. For the specified abnormal load, the following actions will be required for the delivery vehicle.

5.22.	314597-A	Action Required
	200te Transformer	HA Special Order (form BE16), up to 8 weeks approval time, plus 5 clear days notice to Police and 5 clear days notice with indemnity to Highways and Bridge Authorities.

**6. Port Information**

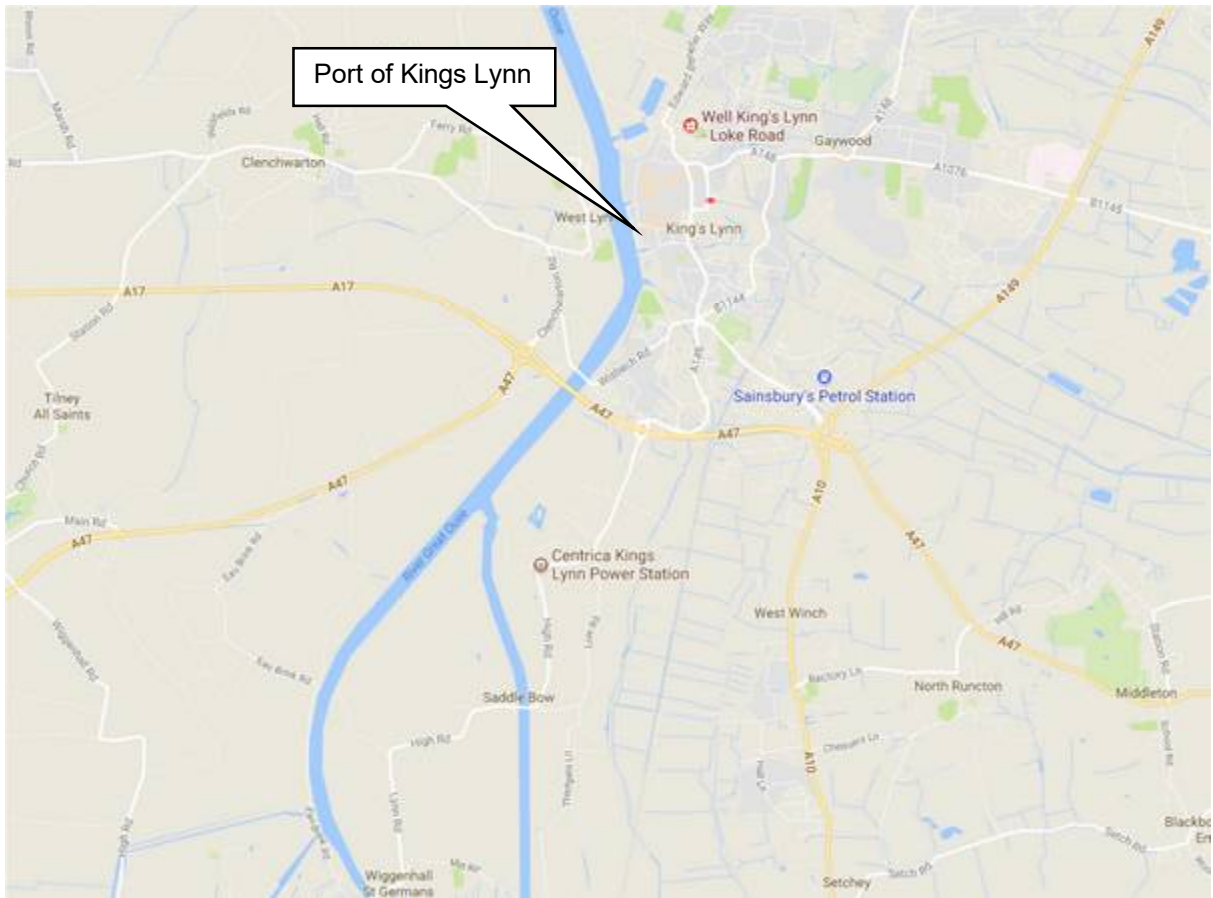

**Kings Lynn**

6.1. The Port of King's Lynn is located on the Wash on the UK's east coast. Trunk roads connect the port to Cambridge, where the M11 leads down to the M25 and east to Leicester and the M1.

Table of normal acceptance dimensions of vessels

Dock, Jetty or quay	Quay Length	Depth of water	Normal acceptance dimensions of vessels			
			Length	Beam	Draught	Approx. dwt
Alexandra Dock	350m	5.3m	119m	13.85m	5.5m	4,000
Bentinck Dock	800m	5.3m	119m	13.85	5.5m	4,000
Riverside Quay	220m	Tidal	140m	20.0m	6.0m	5,500

**Alexandra Dock**



## 7. Responses from Statutory Consultees (Structures Suitability)

7.1. The loading information for this transformer configuration has been sent to the relevant authorities to ascertain if there are any issues with weights and structures within the areas of the Authorities jurisdiction – Details of the authorities can be found below.

7.2. For the purposes of the responses below, the routes referred to are as follows

### Route:

- Exit Kings Lynn Harbour onto Edward Benerfer Way,
- Continue on Edward Benerfer Way to merge onto Grimston Road A148.
- Continue on A148 to roundabout junction with A149 Queen Elizabeth Way,
- At roundabout turn right onto A149 Queen Elizabeth Way,
- Continue on A149 through 2 roundabouts to roundabout junction with A47,
- At roundabout turn left onto A47,
- At roundabout turn left onto A47,
- At roundabout, continue on A47,
- At roundabout continue on A47,  
Continue on A47 to proposed site entrance on the right hand side at approx. OS Grid refs: TF 89245 11382.

7.3. The following summarises the correspondence between the relevant authorities. The detailed responses can be viewed in APPENDIX 3.

County Council Highways	Issues?	Contact Name	Email Address	Phone Number
Norfolk Council	No	Mark North	<a href="mailto:Pandt.bridges@norfolk.gov.uk">Pandt.bridges@norfolk.gov.uk</a>	01603 223804
Area 6	No Comment	John Hughes	<a href="mailto:John.Hughes@kier.co.uk">John.Hughes@kier.co.uk</a>	01223 255255
Network Rail	No	Katie Nicholson	<a href="mailto:Katie.Nicholson@networkrail.co.uk">Katie.Nicholson@networkrail.co.uk</a>	01908 783 140
Historic Railways Estate	No	Tania Howell	<a href="mailto:Tania.Howell@jacobs.com">Tania.Howell@jacobs.com</a>	0118 946 8911
Canal and river trust	Not responded	N/A	<a href="mailto:abnormal.loads@canalrivertrust.org.uk">abnormal.loads@canalrivertrust.org.uk</a>	0113 2005759

### Summary of Structural Issues

7.4. At the time of issue, Canal and River Trust have yet to respond and Area 6 could not comment without a formal BE16 application. Responses from the other authorities in the table above have not highlighted any structural issues.

## 8. Route Assessment

8.1. This section of the report illustrates in detail the pinch points and routes for the delivery of all abnormal load components from Kings Lynn Harbour to Norfolk Vanguard.

### 8.2. Route

Start Location	Kings Lynn Harbour	Distance of Route	Km	Miles
Via:	A149/A47		34.1	21.2
<ul style="list-style-type: none"> <li>• Exit Kings Lynn Harbour onto Edward Benerfer Way,</li> <li>• Continue on Edward Benerfer Way to merge onto Grimston Road A148.</li> <li>• Continue on A148 to roundabout junction with A149 Queen Elizabeth Way,</li> <li>• At roundabout turn right onto A149 Queen Elizabeth Way,</li> <li>• Continue on A149 through 2 roundabouts to roundabout junction with A47,</li> <li>• At roundabout turn left onto A47,</li> <li>• At roundabout, turn left onto A47,</li> <li>• At roundabout, continue on A47,</li> <li>• At roundabout, continue on A47,</li> <li>• Continue on A47 to site entrance on the right hand side at approx. OS Grid ref: TF 89275 11404.</li> </ul>				

### 8.3. Map Overview

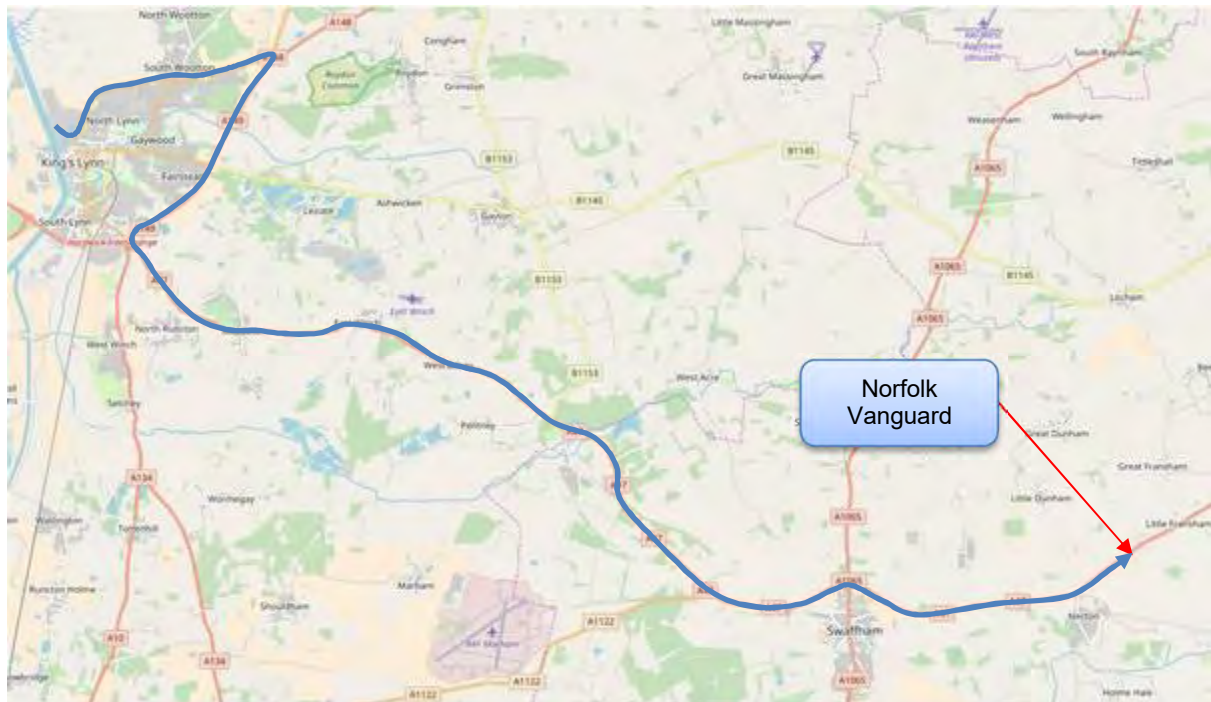



**8.4. Map Extract**

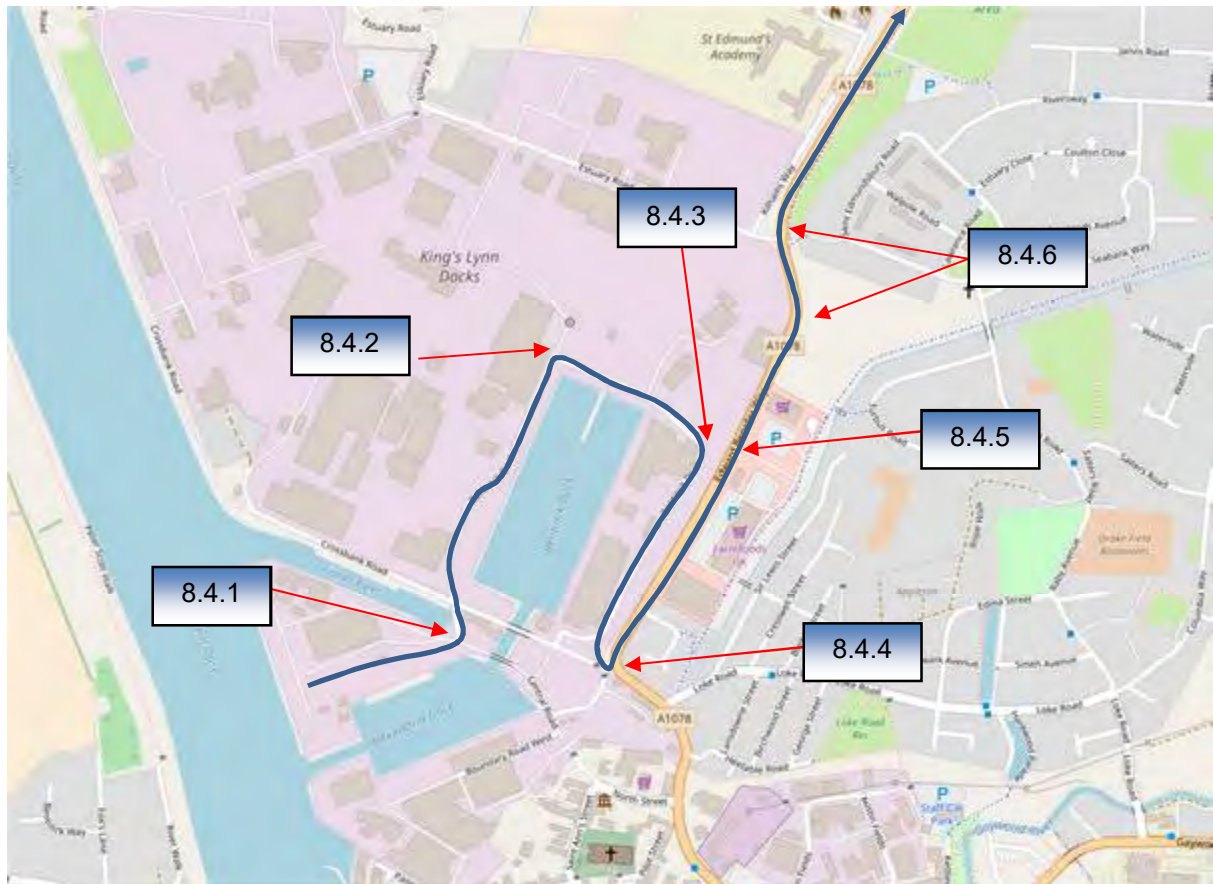



**KEY – Colour coding of modification requirements**

	Indicates major modifications are required i.e. Road widening, street furniture etc.		Indicates manoeuvre or minor modifications i.e. contraflow manoeuvre.		No modifications required.
--	--	--	---	--	----------------------------



8.4.1.1. – Aerial View of Location



8.4.1.2. – View prior to junction



8.4.1.3. – View at crossing



8.4.1.4. – View after crossing

**Description:** From the Heavy Lift Quay turn left within the dock to avoid the bridges.

Distance from previous Pinch Point	N/A	Distance to following Pinch Point	0.25km
------------------------------------	-----	-----------------------------------	--------

Modification required	Reason for Modification	Additional Information:
Manual steering required	To assist navigation	Loaded vehicle will navigate this location without any issues.

<b>Item No:</b>	<b>Title</b>	<b>OS Grid Ref:</b>	TF 61628 20743	<b>COLLETT</b> EXPERTS IN MOTION
<b>8.4.1</b>	Exit form he Quay	<b>Customer</b>	RHDHV	
		<b>Project</b>	Norfolk Vanguard	
		<b>Drawing Nos</b>	N/A	



8.4.2.1. – Aerial View of Location

8.4.2.2. – View prior to bend



8.4.2.3. – View at crossing



8.4.2.4. – Reverse view of bend

Description: Continue through the port to 90° right hand bend.

Distance from previous Pinch Point: 0.25km      Distance to following Pinch Point: 0.05km

Modification required	Reason for Modification	Additional Information:
Street furniture/Manual steering	To provide clear envelope	Street furniture to be cleared on inside of bend to allow navigation.

Item No:	Title	OS Grid Ref:	TF 61756 21132	<b>COLLETT</b> EXPERTS IN MOTION
<b>8.4.2</b>	90° Right hand bend within the port	Customer	RHDHV	
		Project	Norfolk Vanguard	
		Drawing Nos	N/A	



8.4.3.1. – Aerial View of Location



8.4.3.2. – View prior to bend



8.4.3.3. – View after bend

Description: Continue through the port to 90 right hand bend.

Distance from previous Pinch Point 0.5km Distance to following Pinch Point 0.25km

Modification required	Reason for Modification	Additional Information:
Street furniture/Manual steering	To provide clear envelope	Area around bend required to be cleared.

<b>8.4.3</b>	Item No:	Title	OS Grid Ref:	TF 61962 21018
			Customer	RHDHV
			Project	Norfolk Vanguard
			Drawing Nos	N/A





8.4.4.1. – Aerial View of Location

8.4.4.2. – Port Exit



8.4.4.3. – Reverse back past Gatehouse

8.4.4.4. – Left turn onto Edward Benefer Way

**Description:** Continue to port exit to junction with Edwards Benefer Way.  
At junction perform a 3 point turning manoeuvre to travel north on Edwards Benefer Way.

Distance from previous Pinch Point	0.25km	Distance to following Pinch Point	0.35km
------------------------------------	--------	-----------------------------------	--------

Modification required	Reason for Modification	Additional Information:
Reverse manoeuvre and manual steering required	To exit the port	Loaded vehicle to turn left out of exit gate, reverse back past gate house and then turn left onto Edwards Benefer Way.

Item No:	Title	OS Grid Ref:	TF 61842 20712	<b>COLLETT</b> EXPERTS IN MOTION
<b>8.4.4</b>	Port exit	Customer	RHDHV	
		Project	Norfolk Vanguard	
		Drawing Nos	314597-100A1.1	



8.4.5.1. – Aerial View of Location



8.4.5.2. – View of splitter island



8.4.5.3. – View on junction



8.4.5.4. – View on junction

Description: Continue on Edwards Benefer Way through junction with St Nicholas Retail Park.  
At junction continue on Edwards Benefer Way

Distance from previous Pinch Point	0.35km	Distance to following Pinch Point	0.30km
------------------------------------	--------	-----------------------------------	--------

Modification required	Reason for Modification	Additional Information:
No modifications required	No issues at this location	Loaded vehicle will navigate past these splitter islands without any issues.

Item No:	Title	OS Grid Ref:	TF 62008 21014
<b>8.4.5</b>	Edwards Benefer Way junction with Retail Park	Customer	RHDHV
		Project	Norfolk Vanguard
		Drawing Nos	N/A





8.4.6.1. – Aerial View of Location



8.4.6.2. – View on left hand bend



8.4.6.3. – View on junction



8.4.6.4. – View on junction

Description: Continue on Edwards Benefer Way through junction with Estuary Road. At junction continue on Edwards Benefer Way.

Distance from previous Pinch Point	0.30km	Distance to following Pinch Point	1.50km
------------------------------------	--------	-----------------------------------	--------

Modification required	Reason for Modification	Additional Information:
Modifications to street furniture required	To provide clear envelope	All street furniture on splitter islands to be removed.

Item No:	Title	OS Grid Ref:	TF 62054 21308
<b>8.4.5</b>	Edwards Benefer Way junction with Estuary Road	Customer	RHDHV
		Project	Norfolk Vanguard
		Drawing Nos	N/A



**8.5. Map Extract**

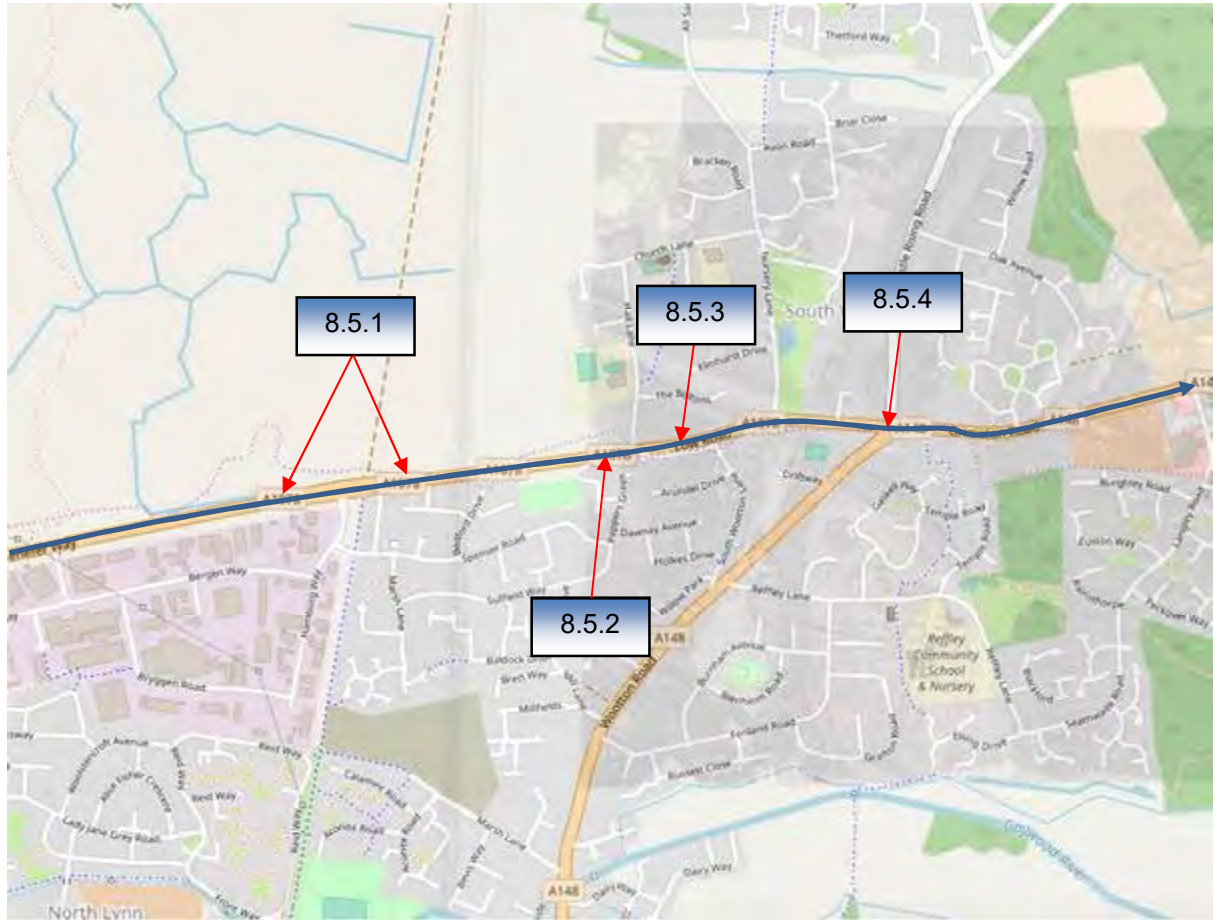





8.5.1.1. – Aerial View of Location | 8.5.1.2. – View on left hand bend



8.5.1.3. – View on junction | 8.5.1.4. – View on junction

**Description:** Continue on Edwards Benefer Way through junction with Hamburg way. At junction continue on Edwards Benefer Way.

Distance from previous Pinch Point: 1.50km | Distance to following Pinch Point: 0.40km

Modification required	Reason for Modification	Additional Information:
No modifications required	No issues at location	Loaded vehicle will navigate this location without any issues.

<b>8.5.1</b>	Item No:	Title	OS Grid Ref:	TF 63321 22213	<b>COLLETT</b> EXPERTS IN MOTION
		Splitter islands at junction of Hamburg Way	Customer	RHDHV	
			Project	Norfolk Vanguard	
			Drawing Nos	N/A	





8.5.2.1. – Aerial View of Location      8.5.2.2. – View of island

Description:		Continue on Edwards Benefer Way.	
Distance from previous Pinch Point		0.40km	Distance to following Pinch Point
			0.19km
Modification required		Reason for Modification	Additional Information:
No modifications required		No issues at location	Loaded vehicle will navigate this location without any issues.
Item No:	Title	OS Grid Ref:	TF 63954 22324
<b>8.5.2</b>	Splitter islands at junction of Hall Way	Customer	RHDHV
		Project	Norfolk Vanguard
		Drawing Nos	N/A



8.5.3.1. – Aerial View of Location      8.5.3.2. – View of island

Description:		Continue on Edwards Benefer Way.	
Distance from previous Pinch Point		0.19km	Distance to following Pinch Point
			0.19km
Modification required		Reason for Modification	Additional Information:
Modifications to street furniture required		To provide clear envelope	Splitter island to be cleared of street furniture.
Item No:	Title	OS Grid Ref:	TF 64045 22334
<b>8.5.3</b>	Splitter islands after junction of Hall Way	Customer	RHDHV
		Project	Norfolk Vanguard
		Drawing Nos	N/A





8.5.4.1. – Aerial View of Location      8.5.4.2. – View of island 3

Description:		Continue on Edwards Benefer Way.	
Distance from previous Pinch Point		0.19km	Distance to following Pinch Point
			0.35km
Modification required		Reason for Modification	Additional Information:
No modifications required		No issues at location	Loaded vehicle will navigate this location without any issues.
Item No:	Title	OS Grid Ref:	TF 64342 22397
<b>8.5.4</b>	Splitter island at junction of Nursery Way	Customer	RHDHV
		Project	Norfolk Vanguard
		Drawing Nos	N/A
		<b>COLLETT</b> EXPERTS IN MOTION	



8.5.5.1. – Aerial View of Location      8.5.5.2. – View of island

Description:		Continue on Edwards Benefer Way to junction with A148. At junction continue onto A148.	
Distance from previous Pinch Point		0.35km	Distance to following Pinch Point
			2.30km
Load:		Reason for Modification	Additional Information:
No modifications required		No issues at location	Loaded vehicle will navigate this location without any issues.
Item No:	Title	OS Grid Ref:	TF 66758 22973
<b>8.5.5</b>	Splitter islands at junction of A148	Customer	RHDHV
		Project	Norfolk Vanguard
		Drawing Nos	N/A
		<b>COLLETT</b> EXPERTS IN MOTION	



**8.6. Map Extract**

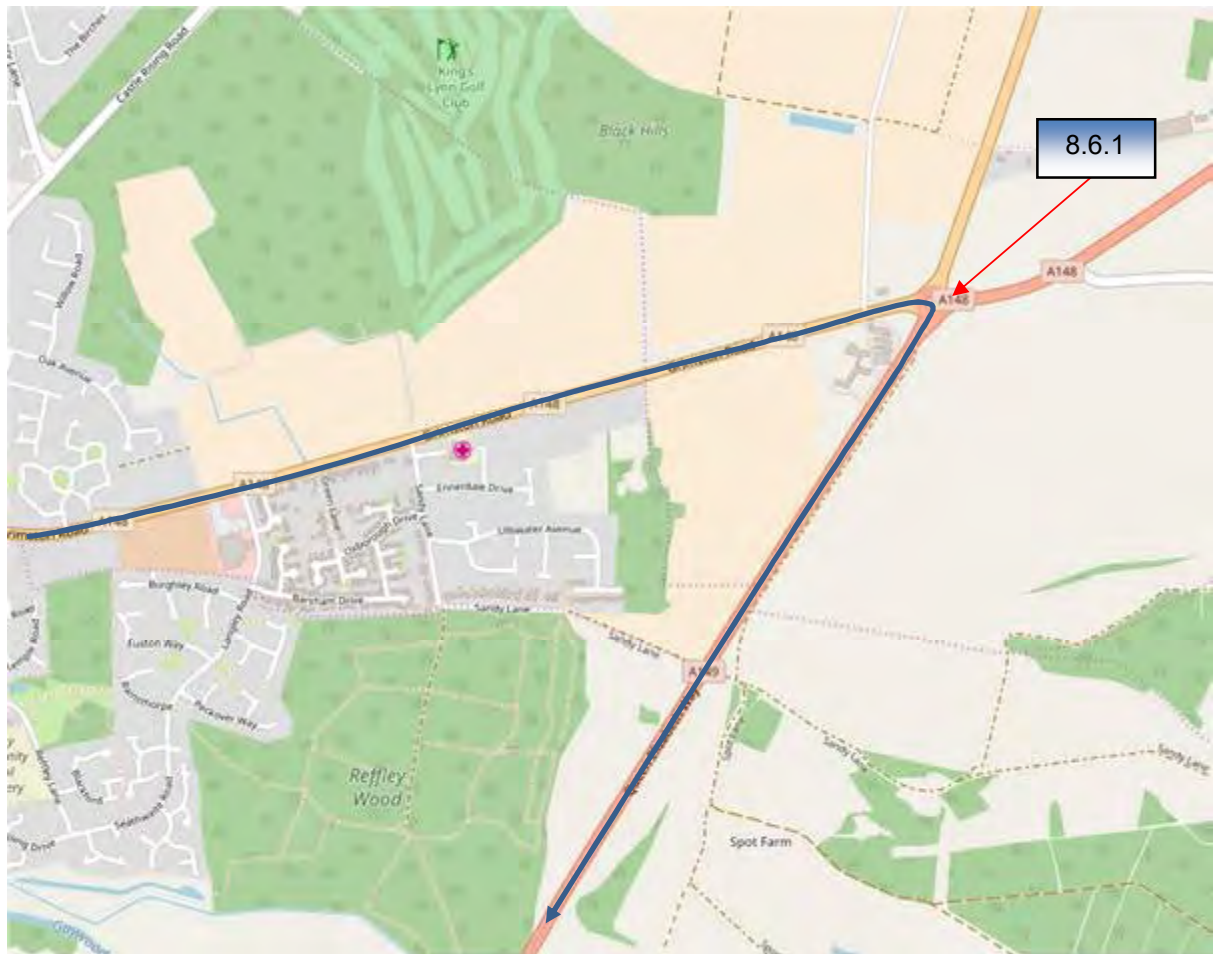



8.6.1.1. – Aerial View of Location

8.6.1.2. – View on prior to roundabout



8.6.1.3. – View on roundabout



8.6.1.4. – View on junction

Description: Continue on A148 to roundabout junction with A149.  
At roundabout turn right onto A149.

Distance from previous Pinch Point	2.30km	Distance to following Pinch Point	3.00km
------------------------------------	--------	-----------------------------------	--------

Load:	Modification required	Reason for Modification	Additional Information:
	Contraflow manoeuvre required	To allow navigation	A contra flow manoeuvre is required at this roundabout in order to navigate this roundabout.

<b>8.6.1</b>	Item No:	Title	OS Grid Ref:	TF 66767 22985	<b>COLLETT</b> EXPERTS IN MOTION
		A148 roundabout junction with A149	Customer	RHDHV	
			Project	Norfolk Vanguard	
			Drawing Nos	314597-120A1.1	

**8.7. Map Extract**







8.7.1.1. – Aerial View of Location

8.7.1.2. – View on prior to roundabout



8.7.1.3. – View on roundabout



8.7.1.4. – View of exit of roundabout

**Description:** Continue on A149 to roundabout junction with A1076.  
At roundabout continue on A149.

Distance from previous Pinch Point	3.00km	Distance to following Pinch Point	2.00km
------------------------------------	--------	-----------------------------------	--------

Modification required	Reason for Modification	Additional Information:
No modifications required	No issues at location	No issues at this roundabout.

<b>8.7.1</b>	Item No:	Title	OS Grid Ref:	TF 65346 20197	<b>COLLETT</b> EXPERTS IN MOTION
		A149 roundabout junction with A1076	Customer	RHDHV	
			Project	Norfolk Vanguard	
			Drawing Nos	314597-130A1.1	



8.7.2.1. – Aerial View of Location		8.7.2.2. – View of entrance to roundabout	
8.7.2.3. – View on roundabout		8.7.2.4. – View of exit of roundabout	
Description:		Continue on A149 to roundabout junction with Sainsbury's. At roundabout continue on A149.	
Distance from previous Pinch Point		2.00km	Distance to following Pinch Point
			1.00km
Modification required		Reason for Modification	Additional Information:
No modifications required		No issues at location	No issues at this roundabout.
Item No:	Title	OS Grid Ref:	TF 63970 18745
<b>8.7.2</b>	A149 roundabout junction with Sainsbury's.	Customer	RHDHV
		Project	Norfolk Vanguard
		Drawing Nos	314597-140A1.1
			<b>COLLETT</b> EXPERTS IN MOTION



8.7.3.1. – Aerial View of Location



8.7.3.2. – View of entrance to roundabout



8.7.3.3. – View on exit of roundabout



8.7.3.4. – View after roundabout exit

Description: Continue on A149 to roundabout junction with A47.  
At roundabout turn right onto A47.

Distance from previous Pinch Point	1.00km	Distance to following Pinch Point	0.90km
------------------------------------	--------	-----------------------------------	--------

Modification required	Reason for Modification	Additional Information:
-----------------------	-------------------------	-------------------------

No modifications required	No issues at location	No issues at this roundabout.
---------------------------	-----------------------	-------------------------------

Item No:	Title	OS Grid Ref:	TF 63297 18102
<b>8.7.3</b>	A149 roundabout junction with A47	Customer	RHDHV
		Project	Norfolk Vanguard
		Drawing Nos	314597-150A1.1





8.7.3.1. – Aerial View of Location      8.7.3.2. – View of entrance to roundabout

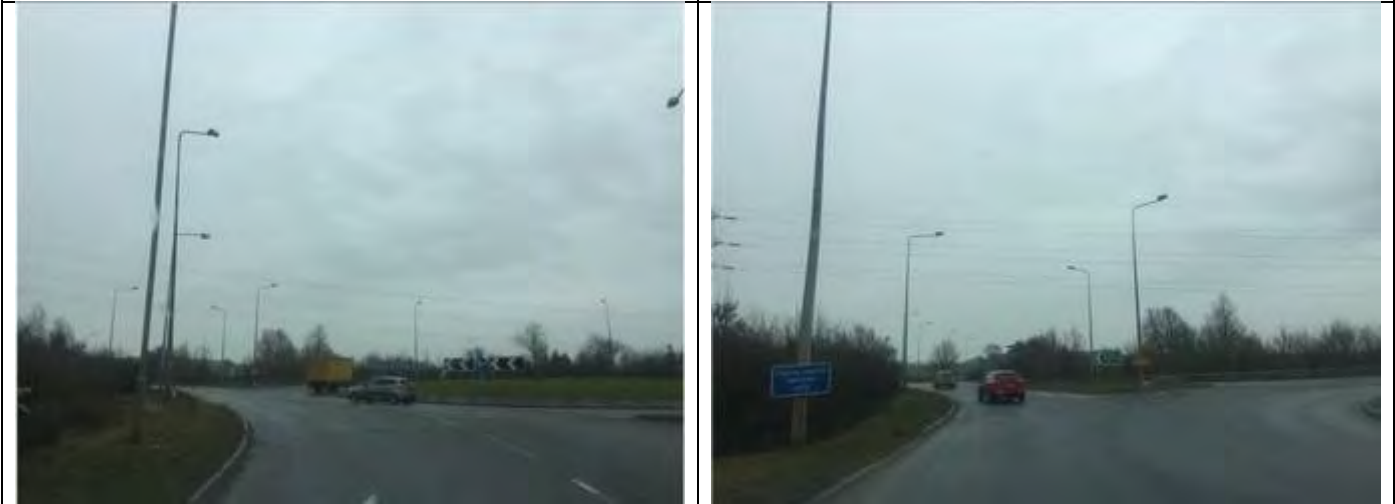

8.7.3.3. – View on roundabout      8.7.3.4. – View of exit of roundabout

**Description:** Continue on A47 to roundabout junction with A47.  
At roundabout turn left onto A47.

Distance from previous Pinch Point	0.90km	Distance to following Pinch Point	18.30km
------------------------------------	--------	-----------------------------------	---------

<b>Load:</b>	Modification required	Reason for Modification	Additional Information:
--------------	-----------------------	-------------------------	-------------------------

	No modifications required	No issues at location	No issues at this roundabout.
--	---------------------------	-----------------------	-------------------------------

<b>Item No:</b>	<b>Title</b>	<b>OS Grid Ref:</b>	TF 63500 18057	<b>COLLETT</b> EXPERTS IN MOTION
<b>8.7.4</b>	A47 roundabout	<b>Customer</b>	RHDHV	
		<b>Project</b>	Norfolk Vanguard	
		<b>Drawing Nos</b>	314597-160A1.1	

**8.8. Map Extract**





8.8.1.1. – Aerial View of Location      8.8.1.2. – View of entrance to roundabout



8.8.1.3. – View on roundabout      8.8.1.4. – View of exit of roundabout

**Description:** Continue on A47 to roundabout junction with A1122.  
At roundabout, continue straight on A47.

Distance from previous Pinch Point	18.30km	Distance to following Pinch Point	3.00km
------------------------------------	---------	-----------------------------------	--------

Load:	Modification required	Reason for Modification	Additional Information:
	No modifications required	No issues at location	No issues at this roundabout.

<b>8.8.1</b>	Item No:	Title	OS Grid Ref:	TF 78322 09905	<b>COLLETT</b> EXPERTS IN MOTION
		A47/A1122 roundabout	Customer	RHDHV	
			Project	Norfolk Vanguard	
			Drawing Nos	314597-170A1.1	



8.8.2.1. – Aerial View of Location | 8.8.2.2. – Reverse view of bend

Description: Continue on A47 to overhead bridge.

Distance from previous Pinch Point: 3.00km | Distance to following Pinch Point: 3.40km

Modification required	Reason for Modification	Additional Information:
No modification required	No issues at location	Clarification of the bridge clearance height was sought from the relevant authorities.  Response has highlighted a clearance height of 5.2m although this should be reassessed prior to any deliveries being undertaken.

Item No:	Title	OS Grid Ref:	TF 81184 09866	
<b>8.8.2</b>	Overhead bridge on A47	Customer	RHDHV	
		Project	Norfolk Vanguard	
		Drawing Nos	N/A	





8.8.3.1. – Aerial View of Location      8.8.3.2. – View of entrance to roundabout



8.8.3.3. – View on roundabout      8.8.3.4. – View of exit of roundabout

**Description:** Continue on A47 to roundabout at junction with Norwich Road.  
At roundabout, continue straight on A47.

<b>Distance from previous Pinch Point</b>	3.40km	<b>Distance to following Pinch Point</b>	3.40km
---	--------	--	--------

	Modification required	Reason for Modification	Additional Information:
	Modifications to street furniture, tree pruning and manual steering required.	To allow navigation	Street furniture on central island of roundabout to be removed due to oversail of loaded vehicle.  Tree on central island to be pruned.

<b>Item No:</b>	<b>Title</b>	<b>OS Grid Ref:</b>	TF 84328 09486	
8.8.3	Roundabout prior to site	<b>Customer</b>	RHDHV	
		<b>Project</b>	Norfolk Vanguard	
		<b>Drawing Nos</b>	314597-180A1.1	





8.8.4.1. – Aerial View of Location



8.8.4.2. – Splitter Island 1



8.8.4.3. – Splitter Island 2



8.8.4.4. – Splitter Island 3

Description: Continue on A47 through Necton.

Distance from previous Pinch Point: 3.40km      Distance to following Pinch Point: 2.10km

Modification required	Reason for Modification	Additional Information:
No modifications required	No issues at this location	Loaded vehicle will navigate past these splitter islands without any issues.

<b>8.8.4</b>	Item No:	Title	OS Grid Ref:	TF 87765 10171	<b>COLLETT</b> EXPERTS IN MOTION
		Splitter islands in Necton	Customer	RHDHV	
			Project	Norfolk Vanguard	
			Drawing Nos	N/A	



8.8.5.1. – Aerial View of Location      8.8.5.2. – View of entrance to roundabout



8.8.5.3. – View on roundabout

Description: Continue on A47 to proposed site entrance.

Distance from previous Pinch Point: 2.10km      Distance to following Pinch Point: N/A

Modification required	Reason for Modification	Additional Information:
New site entrance to be constructed	To allow access into site	Swept Path Analysis has been undertaken on the proposed site entrance design and showed that the loaded vehicle could access the site based on that design.

<b>8.8.5</b>	Item No:	Title	OS Grid Ref:	TF 89255 11397	<b>COLLETT</b> EXPERTS IN MOTION
		Proposed site entrance location	Customer	RHDHV	
			Project	Norfolk Vanguard	
			Drawing Nos	314597-190A1.1	

## 9. Recommendations

- 9.1. If suitable agreements and necessary amendments to the route can be made with both the highway authorities and land owners then this route is recommended for the delivery of all the components.
- 9.2. These recommendations are made from a purely transport orientated view, and do not consider any political issues in terms of land ownership, or any other precincts raised, that may otherwise be restrictive. It is recommended to have adequate warning signs implemented to warn other road users at critical points along the route.
- 9.3. All hedges, shrubs, bushes, trees and overhanging branches along the nominated routes must be trimmed to allow a minimum envelope on the road of 7.5m wide by 7.5m high for load A and for load B they should be 6.0m by 6.0m.
- 9.4. All street furniture, signage etc. along the nominated route must be removed to allow a minimum envelope on the road of 7.5m by 7.5m high for load A and for load B they should be 6.0m by 6.0m. Other specific street furniture has been nominated in this report to facilitate 'over-sailed' and 'swept' areas.

## 10. Important notes

- 10.1. The loaded configuration is based on a generic load size identified by Royal Haskoning DHV. No technical drawings were received of the Transformer and it is possible that the load cannot be loaded in the configuration identified in this report. If this is the case, it may result in different loaded dimensions and as a result, the route becoming unsuitable.
- 10.2. Police escort or Pilot car will be required for all component trailers to negotiate the route, in order to assist with traffic control and control oncoming traffic flow.
- 10.3. The information contained in this report is privileged and confidential and is for the exclusive use of the client nominated herein.
- 10.4. All access diagrams and assessments are made and calculated for the road movement of loaded trailer equipment carrying the components. These dimensions are based on the turning circles and specification of Collett & Sons Ltd trailer equipment.
- 10.5. Land take is usually referred to when land is required from Private Land Owners; road widening is usually referred to when land is required within highways boundaries. The boundaries between private land and highways property are assumed by using obvious demarcation such as fence lines/hedges etc. It should be noted that actual boundaries between highways and private land are not substantiated in this report and can only be authenticated by carrying out land searches.
- 10.6. All drawings produced of swept path diagrams are illustrated by using the automatic steering principle for the steerable trailers, unless otherwise stated. However, all steerable trailers have a manual override system that if used will alter the path of the trailer.
- 10.7. All drawings are produced using Ordnance Survey 'OS MasterMap' mapping data, unless stated otherwise. Street furniture is not included on OS MasterMap data, this is plotted by taking measurements on site with a tape, actual road widths are also checked and adjusted on the map data accordingly. Where adjustments to the OS MasterMap data have been made this is indicated as 'adjusted' on the drawing.
- 10.8. All route assessment, proposed land-take and removal/re-instatement of nominated street furniture is deemed accurate by Collett & Sons Ltd at the date that this report is created. We cannot be held responsible for the development of future road schemes or alterations to the routes surveyed that may leave this report inaccurate.



## 11. List of Drawing Numbers

### 11.1. Transformer

Drawing No	Title
314597-100A1.1	Exit from Kings Lyn port
314597-120A1.1	A148 roundabout junction with A149
314597-130A1.1	A149 roundabout junction with A1076
314597-140A1.1	A149 roundabout junction with Sainsbury's
314597-150A1.1	A149 roundabout junction with A47
314597-160A1.1	A47 Roundabout
314597-170A1.1	A47/A1122 Roundabout
314597-180A1.1	A47/Norwich Road Roundabout
314597-190A1.1	Proposed site entrance off A47

# APPENDIX 1 - ELEVATION DRAWINGS OF SWEEP PATH MODELS

1 2 3 4 5 6 7 8 9 10 11 12 13

**PLAN & SIDE ELEVATION VIEW. SCALE 1:200**

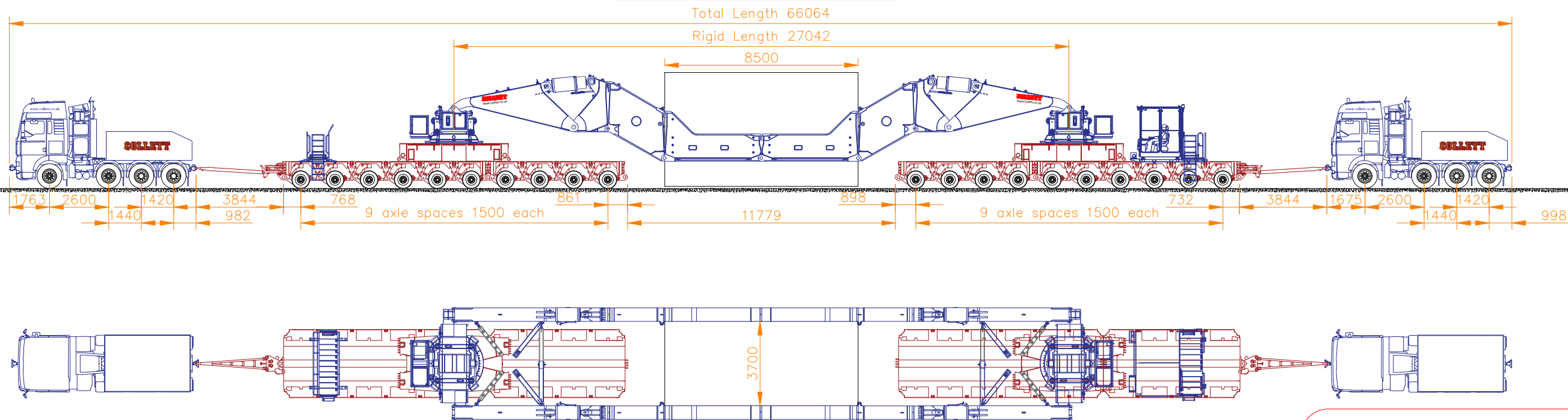

**For Information**

**TRAILER END ELEVATION VIEW. SCALE 1:50**

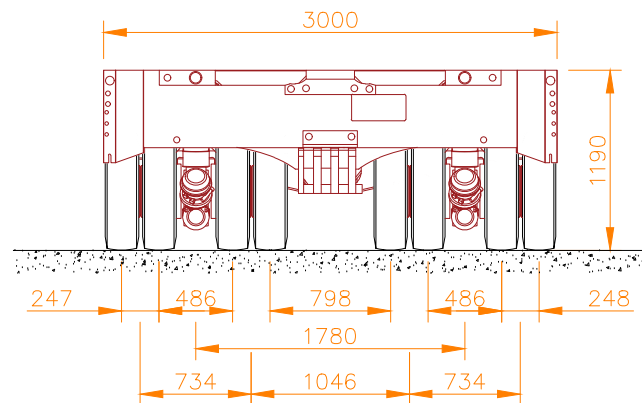

**END ELEVATION VIEW. SCALE 1:50**

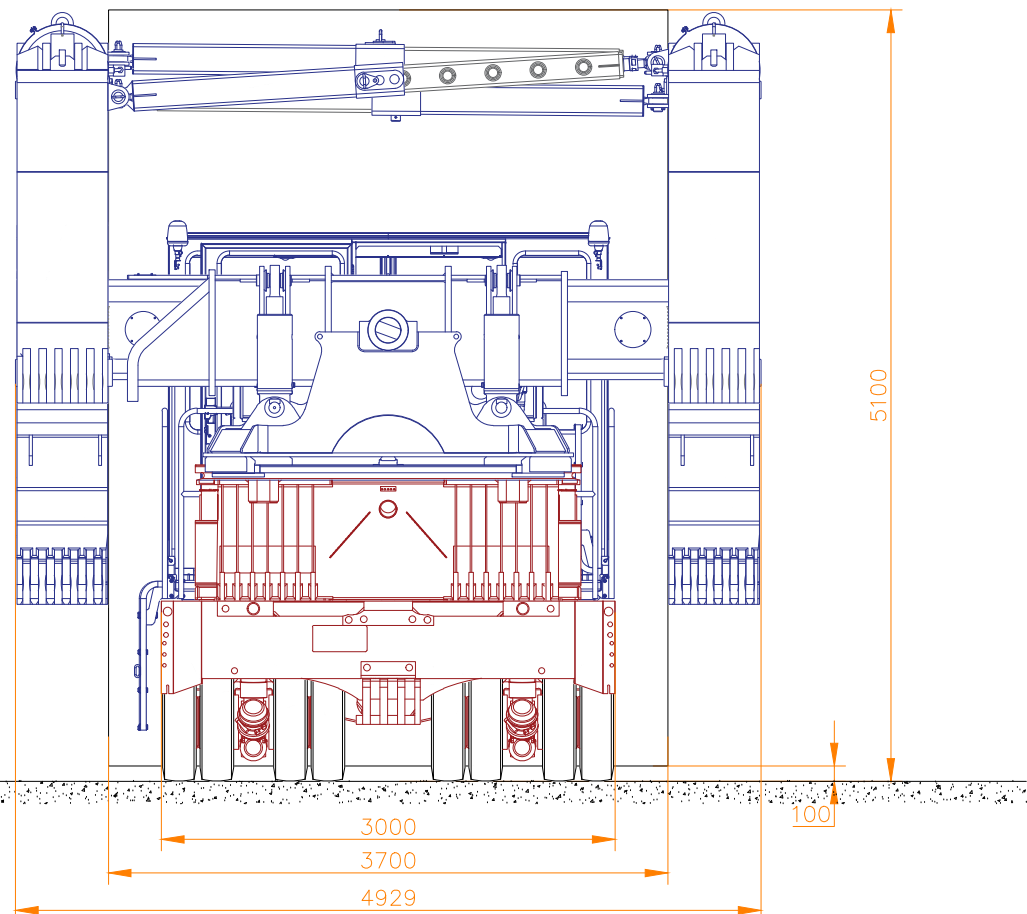

1. THIS DRAWING IS PRELIMINARY AND IS RELEASED FOR INFORMATION ONLY.
2. ALL DIMENSIONS ARE IN MILLIMETRES (mm) UNLESS OTHERWISE STATED.
3. ALL WEIGHTS ARE IN METRIC TONNES (t) UNLESS OTHERWISE STATED.
4. THE CLIENT IS RESPONSIBLE FOR THE PREPARATION OF THE TRANSPORT AREAS TO ENSURE THAT IT IS CAPABLE OF ACCOMMODATING THE LOADS GENERATED BY THE TRAILERS DURING ALL TRANSPORT / LOADING AND UNLOADING OPERATIONS. GROUND TO BE SUITABLY COMPACTED AND LEVELLED FOR A SAFE AND CONVENIENT TRANSPORT OPERATION.
5. THE CLIENT IS RESPONSIBLE FOR THE STRUCTURAL INTEGRITY OF THE LOAD TRANSPORTED.
6. THE CLIENT IS TO IDENTIFY AND CONFIRM THE SUITABILITY OF THE SUPPORT POINTS ON THE LOAD TO BE UTILISED DURING TRANSPORT. IT IS ASSUMED THE TRANSFORMER WILL BE FITTED WITH TRANSPORT BRACKETS.
7. SECURE CARGO ONTO THE TRAILER USING LASHING MATERIAL TO PREVENT SLIDING AND/OR TIPPING OF THE LOAD. ALL STRAPS AND CHAINS TO BE TIGHTENED WITH RATCHET BINDERS. ANTI SLIP RUBBER MATTING TO BE USED BETWEEN THE TRAILER AND THE BASE OF THE LOAD INCLUDING ALL STEEL CONTACT AREAS TO PROMOTE FRICTION.
8. ALL EQUIPMENT IS SUPPLIED IN ACCORDANCE WITH COLLETT & SONS LIMITED TERMS AND CONDITIONS, AND THE RELEVANT R.H.A. 2009 TERMS AND CONDITIONS.
9. WITHOUT AUTHORISED SIGNATURES THIS DOCUMENT IS UNCONTROLLED, NOT BINDING AND FOR INDICATIVE PURPOSES ONLY.

Rev:	Drawn by:	Date:	Checked by:	Date:
00	A.Abdallah	19/03/2018	S.Mangham	19/03/2018
Description: First Issue				

Client:	Royal Haskoning DHV
Project:	Norfolk Vanguard
Title:	200 ton Transformer Transport Arrangement

Weights Table		
Type	Description	Weight
Type of Trailer	20 Axle Girder Bridge Combination	132.860 t
Type of Load	Transformer	200.000 t
	Total loaded weight excluding tractor units	332.860 t
	Load per axle line on trailer (equivalent to 2 file)	16.643 t
	Load per axle per file	8.322 t
	Load per wheel	2.080 t
Abnormal Load Classification: Special Order (BE16)		

**COLLETT**  
EXPERTS IN MOTION

COLLETT & SONS LTD  
Mistral Point  
A.W Nielsen Road  
Goole  
East Yorkshire  
DN14 6UE

Tel: 08456 255233  
Fax: 08456 255277  
Web: [www.collett.co.uk](http://www.collett.co.uk)

THIS DRAWING AND ALL THE INFORMATION IT CONTAINS ARE THE PROPERTY OF COLLETT & SONS LTD AND SHALL BE TREATED AS CONFIDENTIAL UNLESS CONTRACTUALLY SPECIFIED OTHERWISE. IT MUST NOT BE COPIED, RE-PRODUCED OR DIVULGED TO A THIRD PARTY WITHOUT THE EXPRESSED PERMISSION FROM COLLETT & SONS LTD.

© 2016 COLLETT & SONS LTD

Paper Size:	Scale:	Project No:	Drawing No:	Sheet No:
A3	As Noted	314597	COL-D-314597-1-1	1 of 1

1 2 3 4 5 6 7 8 9 10 11 12 13

## APPENDIX 2 – SWEPT PATH ANALYSIS



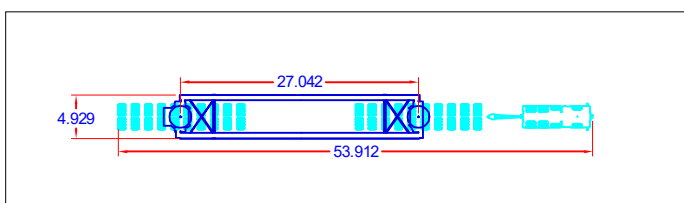

Swept Path indicates trailer utilising MANUAL steering

20 Row Girder Bridge Arrangement for the movement of a 200Te Transformer

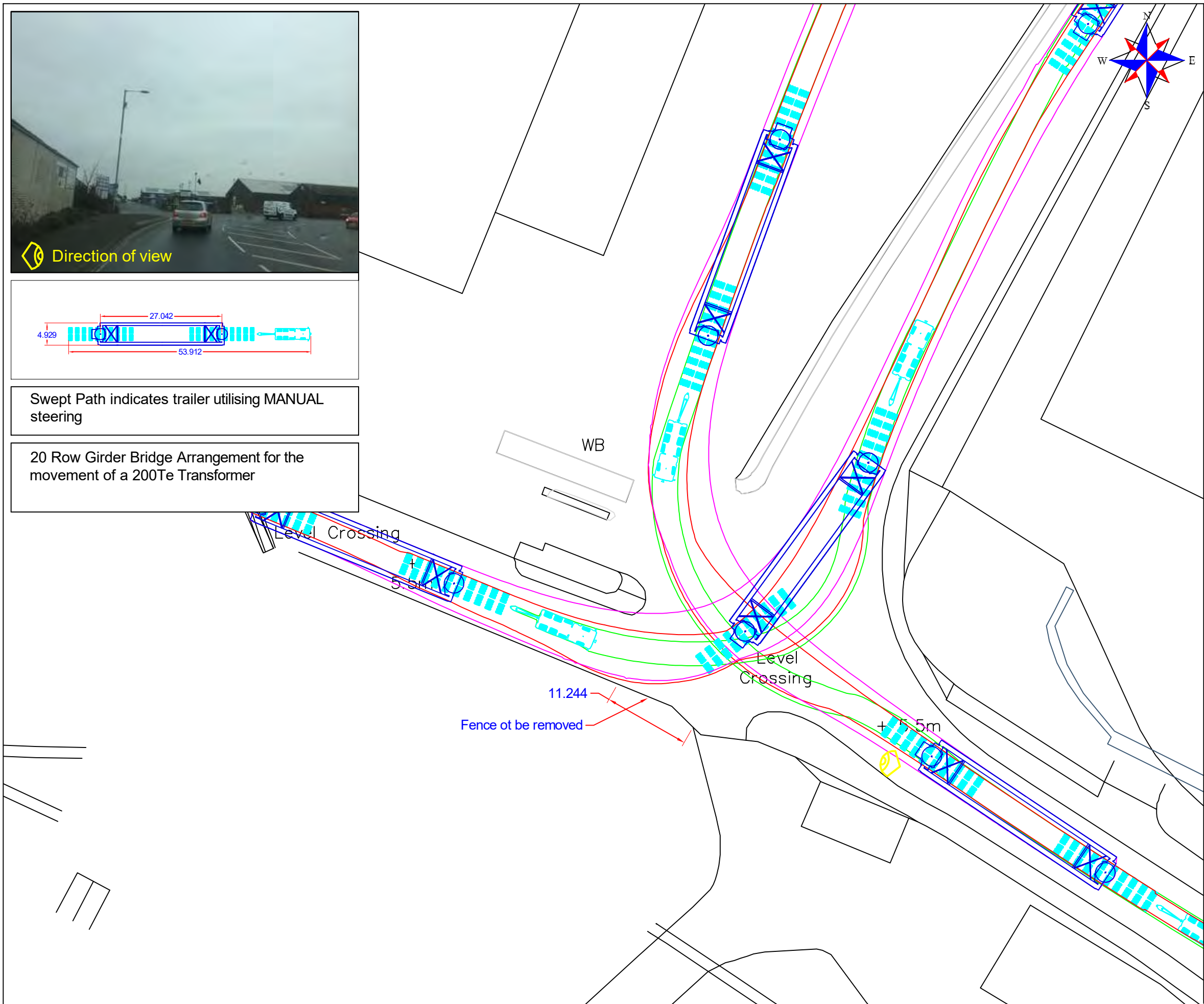

Exit Kings Lynn port onto Edward Benefer Way.

**\*\*Caution\*\***

- A reverse manoeuvre is required when exiting the port in order to avoid modifications.
- Vehicle to turn left onto Edward Benefer towards town centre then reverse back into Port Entrance.
- Vehicle will then turn left onto Edward Benefer Way..

UK Grid Reference: TF 61846 20715

- The swept path analysis provided is produced from a purely transport orientated view, and does not consider any political issues in terms of land ownership, or any other precincts raised, that may otherwise be restrictive.
- The drawing has been produced from data created by Collett. A site visit has **not** been conducted to verify road widths or the presence of street furniture.
- All swept path diagrams and assessments are made and calculated for the road movement of loaded trailer equipment carrying Turbine components. These dimensions are based on the turning circles and specification of Collett & Sons Ltd trailer equipment.
- This SPA is a means of providing evidence of minimum requirements of any one vehicle as a footprint and there is no safety factor or margin included.
- Turbine delivery vehicles can be both left and right hand drive vehicles, therefore due to drivers perception it must be assumed that every vehicle will not follow the exact same line and so a margin of additional space should be allowed for.
- Land take is usually referred to when land is required from Private Land Owners; road widening is usually referred to when land is required within highways boundaries. The boundaries between private land and highways property are assumed by using obvious demarcation such as fence lines/hedges etc. It should be noted that actual boundaries between highways and private land are not substantiated in this report and can only be authenticated by carrying out land searches.
- Police escorts and permits will be required for the movement of all of the components. Form 'BE16' permits will also be required to undertake the movement of the vehicle shown in the swept path analysis. These permits are at the discretion of the Highway Agency (HA). Therefore, approval of these 'permits for movements' by the HA are a major consideration before the physical capability to deliver these components are undertaken.
- In critical areas, where modifications are required, the road construction must be formed to the minimum specification contained in the Turbine Manufactures Transport Guidance Notes.
- The Turbine Manufactures Transport Guidance Notes will state the minimum road width required for the transport of components. Any roads below this stated width will require widening to reflect this regardless of any swept path analysis not indicating modifications.
- The information is privileged and confidential and is for the exclusive use of the nominated client.
- All dimensions in meters

- Area within red outline will be swept by tractor and trailer axles
- ▨ Hatched area within red outline to be levelled and prepared to accept axle loadings
- Area within magenta outline will be oversailed by load and projections
- Area within green outline will be oversailed by trailer body

	<b>COLLETT &amp; SONS LIMITED</b> Victoria Terminal TEL: +44(0)8456 255288 Albert Road FAX: +44(0)8456 255244 Halifax, HX2 0DF WEB: www.collett.co.uk	DRAWN S.MANGHAM DATE 20/03/2018 SCALE 1:500	TITLE MAPPING ORDNANCE SURVEY Not Adjusted SIZE A3 PINCH POINT IDENTIFIED BY COLLETT	EXIT KINGS LYNN PORT ONTO EDWARD BENEFER WAY CUSTOMER ROYAL HASKONING DHV SITE NORFOLK VANGUARD DWG. NO 314597-100A1.1
--	--	---	---	--



Direction of view

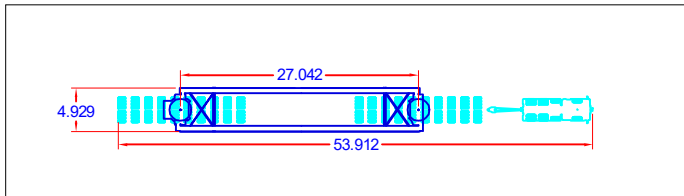

Swept Path indicates trailer utilising MANUAL steering

20 Row Girder Bridge Arrangement for the movement of a 200Te Transformer

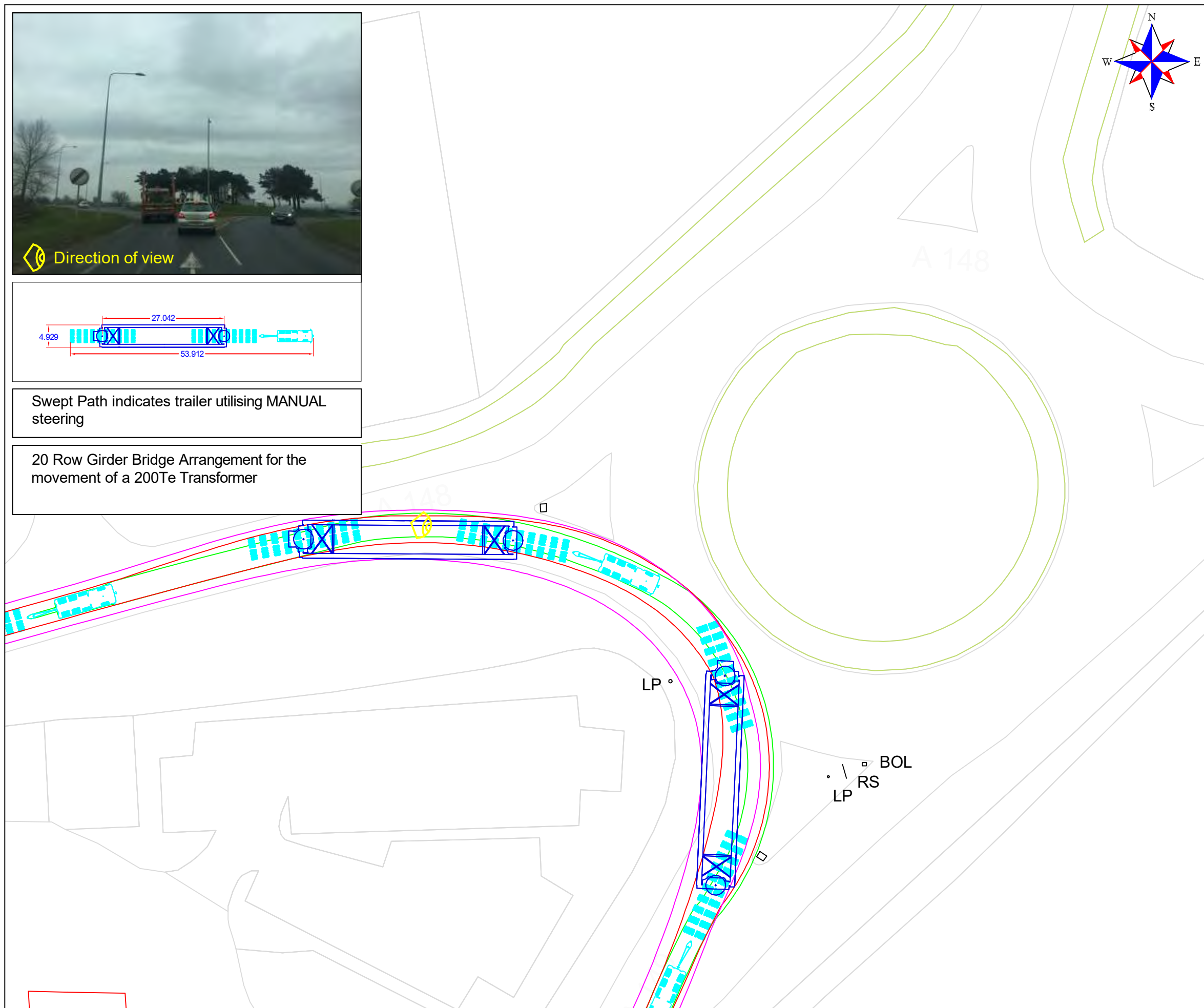

Continue on A148 to roundabout junction with A149 Queen Elizabeth Way,

**\*\*Caution\*\***

- Loaded vehicle will navigate this roundabout utilising a contraflow manoeuvre.

UK Grid Reference: TF 66754 22967

- The swept path analysis provided is produced from a purely transport orientated view, and does not consider any political issues in terms of land ownership, or any other precincts raised, that may otherwise be restrictive.
- The drawing has been produced from data created by Collett. A site visit has not been conducted to verify road widths or the presence of street furniture.
- All swept path diagrams and assessments are made and calculated for the road movement of loaded trailer equipment carrying Turbine components. These dimensions are based on the turning circles and specification of Collett & Sons Ltd trailer equipment.
- This SPA is a means of providing evidence of minimum requirements of any one vehicle as a footprint and there is no safety factor or margin included.
- Turbine delivery vehicles can be both left and right hand drive vehicles, therefore due to drivers perception it must be assumed that every vehicle will not follow the exact same line and so a margin of additional space should be allowed for.
- Land take is usually referred to when land is required from Private Land Owners; road widening is usually referred to when land is required within highways boundaries. The boundaries between private land and highways property are assumed by using obvious demarcation such as fence lines/hedges etc. It should be noted that actual boundaries between highways and private land are not substantiated in this report and can only be authenticated by carrying out land searches.
- Police escorts and permits will be required for the movement of all of the components. Form 'BE16' permits will also be required to undertake the movement of the vehicle shown in the swept path analysis. These permits are at the discretion of the Highway Agency (HA). Therefore, approval of these 'permits for movements' by the HA are a major consideration before the physical capability to deliver these components are undertaken.
- In critical areas, where modifications are required, the road construction must be formed to the minimum specification contained in the Turbine Manufactures Transport Guidance Notes.
- The Turbine Manufactures Transport Guidance Notes will state the minimum road width required for the transport of components. Any roads below this stated width will require widening to reflect this regardless of any swept path analysis not indicating modifications.
- The information is privileged and confidential and is for the exclusive use of the nominated client.
- All dimensions in meters

- Area within red outline will be swept by tractor and trailer axles
- ▨ Hatched area within red outline to be levelled and prepared to accept axle loadings
- Area within magenta outline will be oversailed by load and projections
- Area within green outline will be oversailed by trailer body

	<b>COLLETT &amp; SONS LIMITED</b> Victoria Terminal TEL: +44(0)8456 255288 Albert Road FAX: +44(0)8456 255244 Halifax, HX2 0DF WEB: www.collett.co.uk	DRAWN S.MANGHAM DATE 20/03/2018 SCALE 1:500	TITLE A148 ROUNDABOUT JUNCTION WITH A149 MAPPING ORDNANCE SURVEY Not Adjusted SIZE A3	CUSTOMER ROYAL HASKONING DHV SITE NORFOLK VANGUARD DWG. NO 314597-120A1.1
	PINCH POINT IDENTIFIED BY COLLETT			

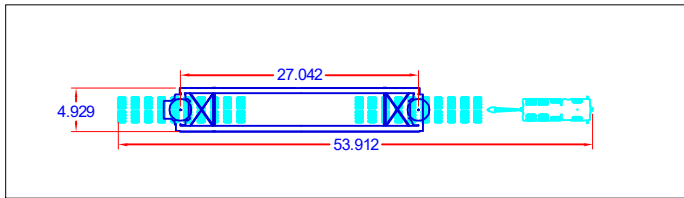

Swept Path indicates trailer utilising MANUAL steering

20 Row Girder Bridge Arrangement for the movement of a 200Te Transformer

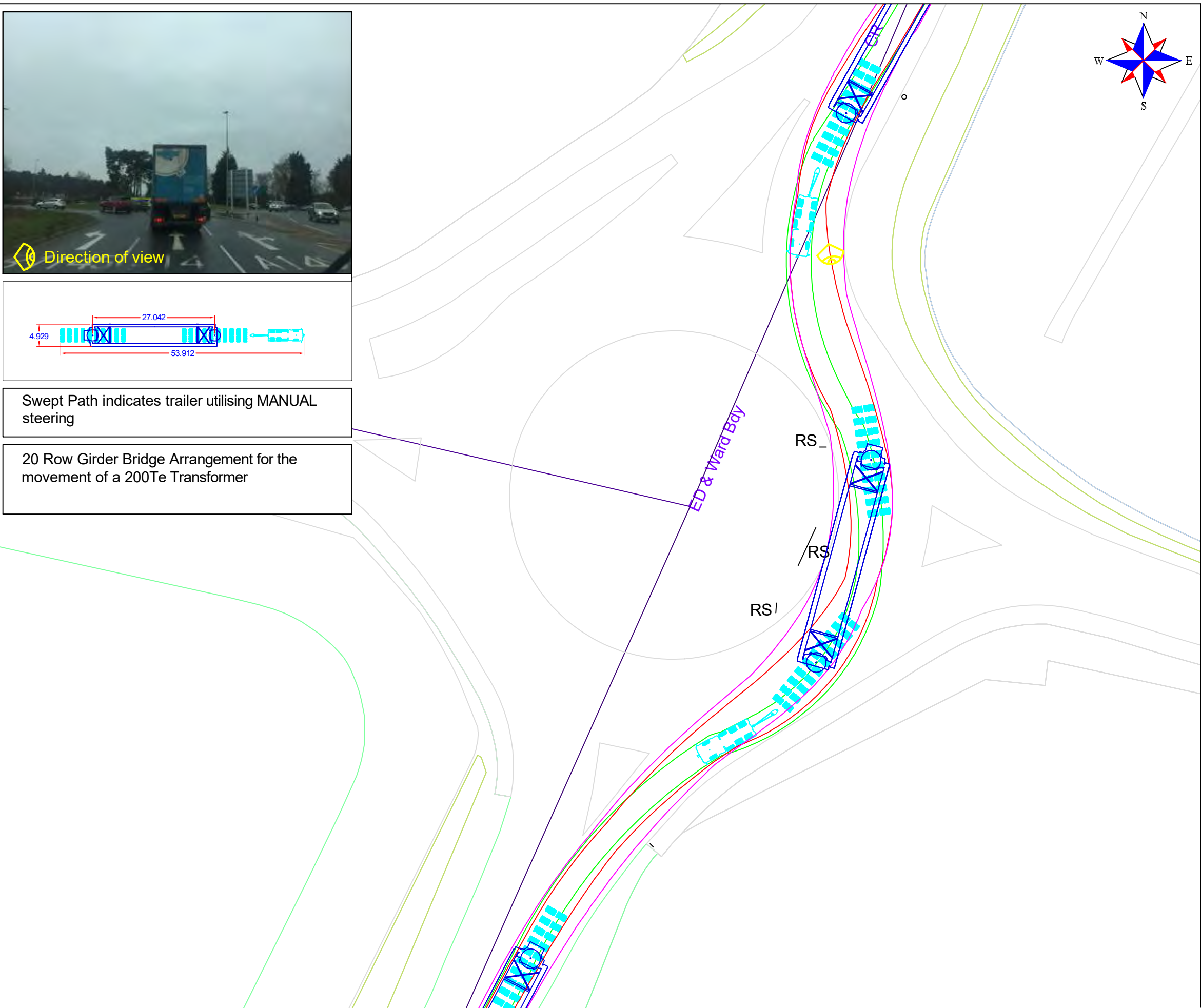

Continue on A149 to roundabout to at junction with A1076.  
At roundabout continue on A149.

**\*\*Caution\*\***

- Loaded vehicle will navigate this roundabout utilising manual steering.

UK Grid Reference: TF 65339 20203

- The swept path analysis provided is produced from a purely transport orientated view, and does not consider any political issues in terms of land ownership, or any other precincts raised, that may otherwise be restrictive.
- The drawing has been produced from data created by Collett. A site visit has not been conducted to verify road widths or the presence of street furniture.
- All swept path diagrams and assessments are made and calculated for the road movement of loaded trailer equipment carrying Turbine components. These dimensions are based on the turning circles and specification of Collett & Sons Ltd trailer equipment.
- This SPA is a means of providing evidence of minimum requirements of any one vehicle as a footprint and there is no safety factor or margin included.
- Turbine delivery vehicles can be both left and right hand drive vehicles, therefore due to drivers perception it must be assumed that every vehicle will not follow the exact same line and so a margin of additional space should be allowed for.
- Land take is usually referred to when land is required from Private Land Owners; road widening is usually referred to when land is required within highways boundaries. The boundaries between private land and highways property are assumed by using obvious demarcation such as fence lines/hedges etc. It should be noted that actual boundaries between highways and private land are not substantiated in this report and can only be authenticated by carrying out land searches.
- Police escorts and permits will be required for the movement of all of the components. Form 'BE16' permits will also be required to undertake the movement of the vehicle shown in the swept path analysis. These permits are at the discretion of the Highway Agency (HA). Therefore, approval of these 'permits for movements' by the HA are a major consideration before the physical capability to deliver these components are undertaken.
- In critical areas, where modifications are required, the road construction must be formed to the minimum specification contained in the Turbine Manufactures Transport Guidance Notes.
- The Turbine Manufactures Transport Guidance Notes will state the minimum road width required for the transport of components. Any roads below this stated width will require widening to reflect this regardless of any swept path analysis not indicating modifications.
- The information is privileged and confidential and is for the exclusive use of the nominated client.
- All dimensions in meters

- Area within red outline will be swept by tractor and trailer axles
- Hatched area within red outline to be levelled and prepared to accept axle loadings
- Area within magenta outline will be oversailed by load and projections
- Area within green outline will be oversailed by trailer body

	<b>COLLETT &amp; SONS LIMITED</b> Victoria Terminal TEL: +44(0)8456 255288 Albert Road FAX: +44(0)8456 255244 Halifax, HX2 0DF WEB: www.collett.co.uk	DRAWN S.MANGHAM DATE 20/03/2018 SCALE 1:500	TITLE A149 ROUNDABOUT JUNCTION WITH B1145 MAPPING ORDNANCE SURVEY Not Adjusted SIZE A3	CUSTOMER ROYAL HASKONING DHV SITE NORFOLK VANGUARD DWG. NO 314597-130A1.1
	PINCH POINT IDENTIFIED BY COLLETT		CUSTOMER ROYAL HASKONING DHV	
	SCALE 1:500		SIZE A3	SITE NORFOLK VANGUARD



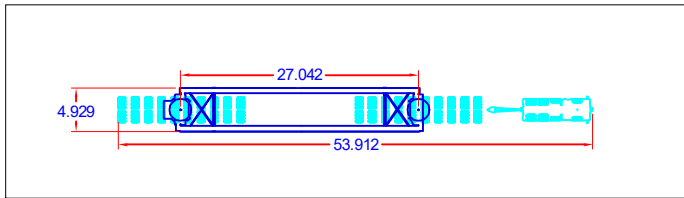

Swept Path indicates trailer utilising MANUAL steering

20 Row Girder Bridge Arrangement for the movement of a 200Te Transformer

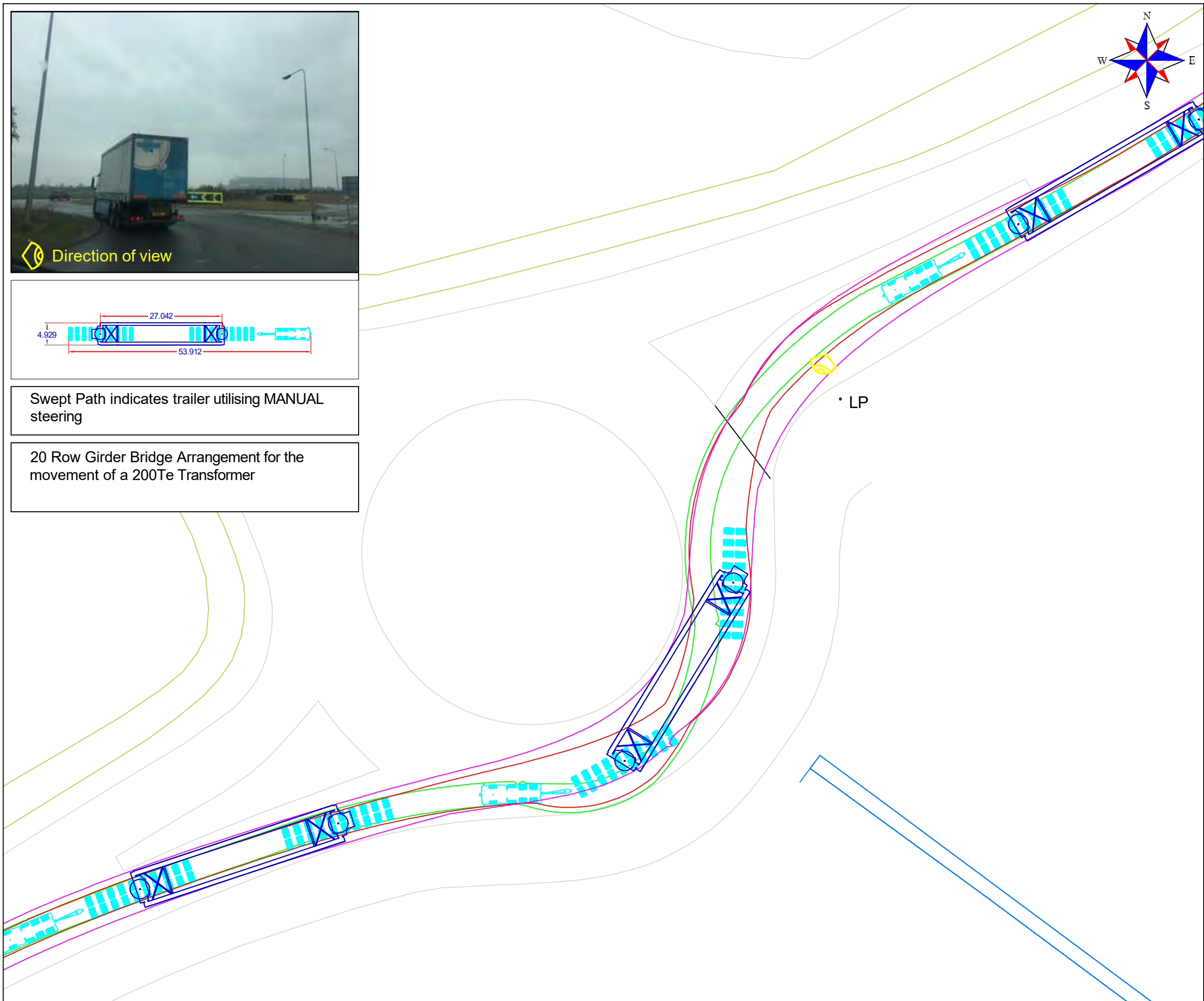

Continue on A149 to roundabout to at junction with Sainburys.  
At roundabout continue on A149.

**\*\*Caution\*\***

- Loaded vehicle will navigate this roundabout utilising manual steering.

UK Grid Reference: TF 63957 18715

- The swept path analysis provided is produced from a purely transport orientated view, and does not consider any political issues in terms of land ownership, or any other precincts raised, that may otherwise be restrictive.
- The drawing has been produced from data created by Collett. A site visit has not been conducted to verify road widths or the presence of street furniture.
- All swept path diagrams and assessments are made and calculated for the road movement of loaded trailer equipment carrying Turbine components. These dimensions are based on the turning circles and specification of Collett & Sons Ltd trailer equipment.
- This SPA is a means of providing evidence of minimum requirements of any one vehicle as a footprint and there is no safety factor or margin included.
- Turbine delivery vehicles can be both left and right hand drive vehicles, therefore due to drivers perception it must be assumed that every vehicle will not follow the exact same line and so a margin of additional space should be allowed for.
- Land take is usually referred to when land is required from Private Land Owners; road widening is usually referred to when land is required within highways boundaries. The boundaries between private land and highways property are assumed by using obvious demarcation such as fence lines/hedges etc. It should be noted that actual boundaries between highways and private land are not substantiated in this report and can only be authenticated by carrying out land searches.
- Police escorts and permits will be required for the movement of all of the components. Form 'BE16' permits will also be required to undertake the movement of the vehicle shown in the swept path analysis. These permits are at the discretion of the Highway Agency (HA). Therefore, approval of these 'permits for movements' by the HA are a major consideration before the physical capability to deliver these components are undertaken.
- In critical areas, where modifications are required, the road construction must be formed to the minimum specification contained in the Turbine Manufactures Transport Guidance Notes.
- The Turbine Manufactures Transport Guidance Notes will state the minimum road width required for the transport of components. Any roads below this stated width will require widening to reflect this regardless of any swept path analysis not indicating modifications.
- The information is privileged and confidential and is for the exclusive use of the nominated client.
- All dimensions in meters

- Area within red outline will be swept by tractor and trailer axles
- ▨ Hatched area within red outline to be levelled and prepared to accept axle loadings
- Area within magenta outline will be oversailed by load and projections
- Area within green outline will be oversailed by trailer body

	<b>COLLETT &amp; SONS LIMITED</b> Victoria Terminal TEL: +44(0)8456 255288 Albert Road FAX: +44(0)8456 255244 Halifax, HX2 0DF WEB: www.collett.co.uk	DRAWN S.MANGHAM DATE 20/03/2018 SCALE 1:500	TITLE A149 ROUNDABOUT JUNCTION WITH SAINBURYS MAPPING ORDNANCE SURVEY Not Adjusted SIZE A3 PINCH POINT IDENTIFIED BY COLLETT	CUSTOMER ROYAL HASKONING DHV SITE NORFOLK VANGUARD DWG. NO 314597-140A1.1
--	--	---	---	---



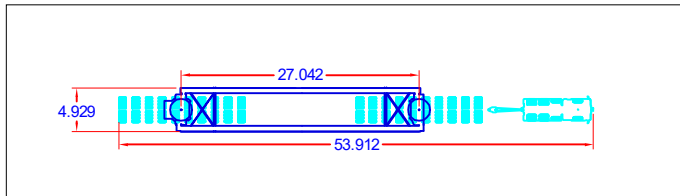

Swept Path indicates trailer utilising MANUAL steering

20 Row Girder Bridge Arrangement for the movement of a 200Te Transformer

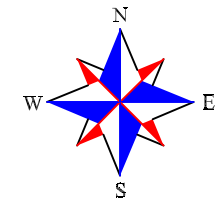

Continue on A149 to roundabout junction with A47,  
At junction turn right onto A47

**\*\*Caution\*\***

- Loaded vehicle will navigate this roundabout utilising manual steering.

UK Grid Reference: TF 63240 18156

- The swept path analysis provided is produced from a purely transport orientated view, and does not consider any political issues in terms of land ownership, or any other precincts raised, that may otherwise be restrictive.
- The drawing has been produced from data created by Collett. A site visit has not been conducted to verify road widths or the presence of street furniture.
- All swept path diagrams and assessments are made and calculated for the road movement of loaded trailer equipment carrying Turbine components. These dimensions are based on the turning circles and specification of Collett & Sons Ltd trailer equipment.
- This SPA is a means of providing evidence of minimum requirements of any one vehicle as a footprint and there is no safety factor or margin included.
- Turbine delivery vehicles can be both left and right hand drive vehicles, therefore due to drivers perception it must be assumed that every vehicle will not follow the exact same line and so a margin of additional space should be allowed for.
- Land take is usually referred to when land is required from Private Land Owners; road widening is usually referred to when land is required within highways boundaries. The boundaries between private land and highways property are assumed by using obvious demarcation such as fence lines/hedges etc. It should be noted that actual boundaries between highways and private land are not substantiated in this report and can only be authenticated by carrying out land searches.
- Police escorts and permits will be required for the movement of all of the components. Form 'BE16' permits will also be required to undertake the movement of the vehicle shown in the swept path analysis. These permits are at the discretion of the Highway Agency (HA). Therefore, approval of these 'permits for movements' by the HA are a major consideration before the physical capability to deliver these components are undertaken.
- In critical areas, where modifications are required, the road construction must be formed to the minimum specification contained in the Turbine Manufactures Transport Guidance Notes.
- The Turbine Manufactures Transport Guidance Notes will state the minimum road width required for the transport of components. Any roads below this stated width will require widening to reflect this regardless of any swept path analysis not indicating modifications.
- The information is privileged and confidential and is for the exclusive use of the nominated client.
- All dimensions in meters

- Area within red outline will be swept by tractor and trailer axles
- Hatched area within red outline to be levelled and prepared to accept axle loadings
- Area within magenta outline will be oversailed by load and projections
- Area within green outline will be oversailed by trailer body



**COLLETT & SONS LIMITED**  
Victoria Terminal TEL: +44(0)8456 255288  
Albert Road FAX: +44(0)8456 255244  
Halifax, HX2 0DF WEB: www.collett.co.uk

DRAWN	S.MANGHAM	TITLE	A149/A47 ROUNDABOUT JUNCTION	
DATE	20/03/2018	MAPPING	ORDNANCE SURVEY <small>Not Adjusted</small>	CUSTOMER
SCALE	1:500	SIZE	A3	PINCH POINT IDENTIFIED BY
			COLLETT	SITE
			NORFOLK VANGUARD	DWG. NO 314597-150A1.1

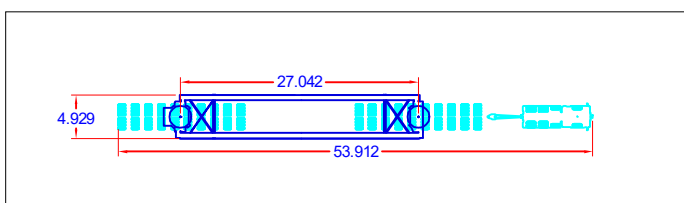

Swept Path indicates trailer utilising MANUAL steering

20 Row Girder Bridge Arrangement for the movement of a 200Te Transformer

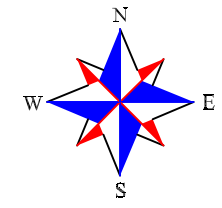

Continue on A47 to roundabout.  
At roundabout, turn left onto A47.

**\*\*Caution\*\***

- Loaded vehicle will navigate this roundabout utilising manual steering.

UK Grid Reference: TF 63500 18063

- The swept path analysis provided is produced from a purely transport orientated view, and does not consider any political issues in terms of land ownership, or any other precincts raised, that may otherwise be restrictive.
- The drawing has been produced from data created by Collett. A site visit has not been conducted to verify road widths or the presence of street furniture.
- All swept path diagrams and assessments are made and calculated for the road movement of loaded trailer equipment carrying Turbine components. These dimensions are based on the turning circles and specification of Collett & Sons Ltd trailer equipment.
- This SPA is a means of providing evidence of minimum requirements of any one vehicle as a footprint and there is no safety factor or margin included.
- Turbine delivery vehicles can be both left and right hand drive vehicles, therefore due to drivers perception it must be assumed that every vehicle will not follow the exact same line and so a margin of additional space should be allowed for.
- Land take is usually referred to when land is required from Private Land Owners; road widening is usually referred to when land is required within highways boundaries. The boundaries between private land and highways property are assumed by using obvious demarcation such as fence lines/hedges etc. It should be noted that actual boundaries between highways and private land are not substantiated in this report and can only be authenticated by carrying out land searches.
- Police escorts and permits will be required for the movement of all of the components. Form 'BE16' permits will also be required to undertake the movement of the vehicle shown in the swept path analysis. These permits are at the discretion of the Highway Agency (HA). Therefore, approval of these 'permits for movements' by the HA are a major consideration before the physical capability to deliver these components are undertaken.
- In critical areas, where modifications are required, the road construction must be formed to the minimum specification contained in the Turbine Manufactures Transport Guidance Notes.
- The Turbine Manufactures Transport Guidance Notes will state the minimum road width required for the transport of components. Any roads below this stated width will require widening to reflect this regardless of any swept path analysis not indicating modifications.
- The information is privileged and confidential and is for the exclusive use of the nominated client.
- All dimensions in meters

- Area within red outline will be swept by tractor and trailer axles
- Hatched area within red outline to be levelled and prepared to accept axle loadings
- Area within magenta outline will be oversailed by load and projections
- Area within green outline will be oversailed by trailer body



**COLLETT & SONS LIMITED**  
 Victoria Terminal TEL: +44(0)8456 255288  
 Albert Road FAX: +44(0)8456 255244  
 Halifax, HX2 0DF WEB: www.collett.co.uk

DRAWN	S.MANGHAM	TITLE	A47 ROUNDABOUT	
DATE	20/03/2018	MAPPING	ORDNANCE SURVEY <small>Not Adjusted</small>	CUSTOMER
SCALE	1:500	SIZE	A3	PINCH POINT IDENTIFIED BY
			COLLETT	SITE
			NORFOLK VANGUARD	DWG. NO 314597-160A1.1

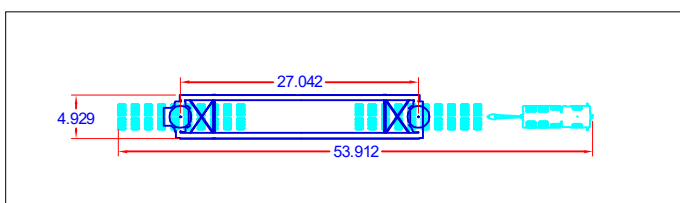

Swept Path indicates trailer utilising MANUAL steering

20 Row Girder Bridge Arrangement for the movement of a 200Te Transformer

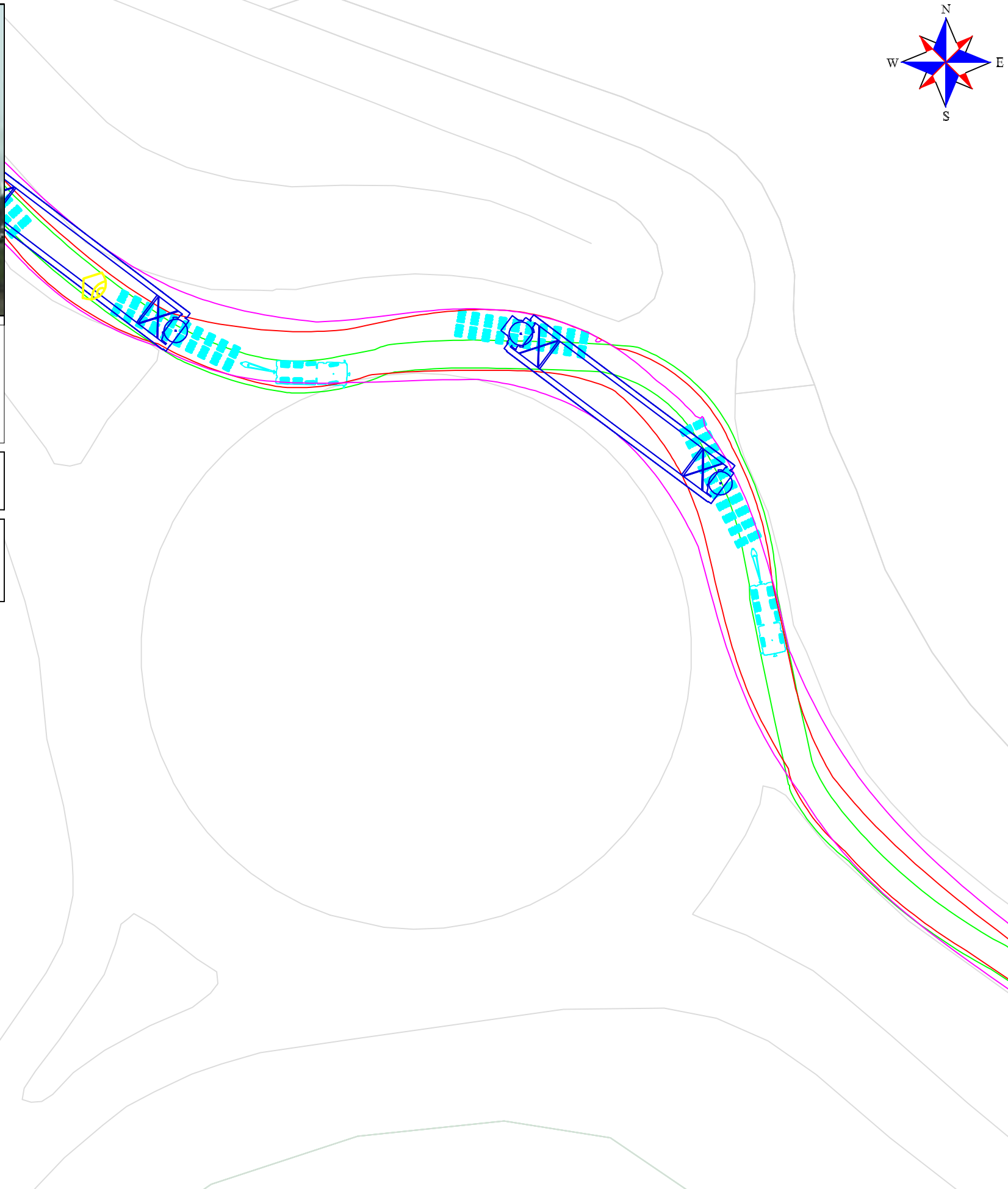
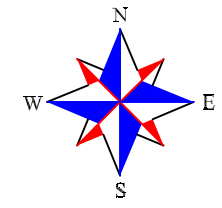

Continue on A47 to roundabout at junction with A1122.  
At roundabout, continue on A47.

**\*\*Caution\*\***

- Loaded vehicle will navigate this roundabout utilising manual steering.

UK Grid Reference: TF 78318 09912

- The swept path analysis provided is produced from a purely transport orientated view, and does not consider any political issues in terms of land ownership, or any other precincts raised, that may otherwise be restrictive.
- The drawing has been produced from data created by Collett. A site visit has not been conducted to verify road widths or the presence of street furniture.
- All swept path diagrams and assessments are made and calculated for the road movement of loaded trailer equipment carrying Turbine components. These dimensions are based on the turning circles and specification of Collett & Sons Ltd trailer equipment.
- This SPA is a means of providing evidence of minimum requirements of any one vehicle as a footprint and there is no safety factor or margin included.
- Turbine delivery vehicles can be both left and right hand drive vehicles, therefore due to drivers perception it must be assumed that every vehicle will not follow the exact same line and so a margin of additional space should be allowed for.
- Land take is usually referred to when land is required from Private Land Owners; road widening is usually referred to when land is required within highways boundaries. The boundaries between private land and highways property are assumed by using obvious demarcation such as fence lines/hedges etc. It should be noted that actual boundaries between highways and private land are not substantiated in this report and can only be authenticated by carrying out land searches.
- Police escorts and permits will be required for the movement of all of the components. Form 'BE16' permits will also be required to undertake the movement of the vehicle shown in the swept path analysis. These permits are at the discretion of the Highway Agency (HA). Therefore, approval of these 'permits for movements' by the HA are a major consideration before the physical capability to deliver these components are undertaken.
- In critical areas, where modifications are required, the road construction must be formed to the minimum specification contained in the Turbine Manufactures Transport Guidance Notes.
- The Turbine Manufactures Transport Guidance Notes will state the minimum road width required for the transport of components. Any roads below this stated width will require widening to reflect this regardless of any swept path analysis not indicating modifications.
- The information is privileged and confidential and is for the exclusive use of the nominated client.
- All dimensions in meters

- Area within red outline will be swept by tractor and trailer axles
- Hatched area within red outline to be levelled and prepared to accept axle loadings
- Area within magenta outline will be oversailed by load and projections
- Area within green outline will be oversailed by trailer body

	<b>COLLETT &amp; SONS LIMITED</b> Victoria Terminal TEL: +44(0)8456 255288 Albert Road FAX: +44(0)8456 255244 Halifax, HX2 0DF WEB: www.collett.co.uk	DRAWN S.MANGHAM DATE 20/03/2018 SCALE 1:500	TITLE A47/A1122 ROUNDABOUT MAPPING ORDNANCE SURVEY Not Adjusted SIZE A3	CUSTOMER ROYAL HASKONING DHV SITE NORFOLK VANGUARD DWG. NO 314597-170A1.1
	PINCH POINT IDENTIFIED BY COLLETT		CUSTOMER ROYAL HASKONING DHV	
	SCALE 1:500		SITE NORFOLK VANGUARD	





Direction of view

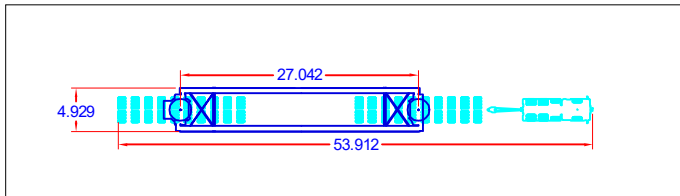

Swept Path indicates trailer utilising MANUAL steering

20 Row Girder Bridge Arrangement for the movement of a 200Te Transformer

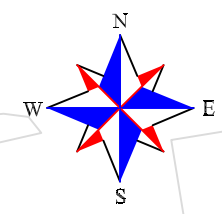

Continue on A47 to roundabout with Norwich Road.  
At roundabout, continue on A47.

**\*\*Caution\*\***

- Road signs on central island of the roundabout to be removed.
- Trees on roundabout to be pruned.
- Girder Bridge to be raised to clear central island.

UK Grid Reference: TF 84305 09509

- The swept path analysis provided is produced from a purely transport orientated view, and does not consider any political issues in terms of land ownership, or any other precincts raised, that may otherwise be restrictive.
- The drawing has been produced from data created by Collett. A site visit has **not** been conducted to verify road widths or the presence of street furniture.
- All swept path diagrams and assessments are made and calculated for the road movement of loaded trailer equipment carrying Turbine components. These dimensions are based on the turning circles and specification of Collett & Sons Ltd trailer equipment.
- This SPA is a means of providing evidence of minimum requirements of any one vehicle as a footprint and there is no safety factor or margin included.
- Turbine delivery vehicles can be both left and right hand drive vehicles, therefore due to drivers perception it must be assumed that every vehicle will not follow the exact same line and so a margin of additional space should be allowed for.
- Land take is usually referred to when land is required from Private Land Owners; road widening is usually referred to when land is required within highways boundaries. The boundaries between private land and highways property are assumed by using obvious demarcation such as fence lines/hedges etc. It should be noted that actual boundaries between highways and private land are not substantiated in this report and can only be authenticated by carrying out land searches.
- Police escorts and permits will be required for the movement of all of the components. Form 'BE16' permits will also be required to undertake the movement of the vehicle shown in the swept path analysis. These permits are at the discretion of the Highway Agency (HA). Therefore, approval of these 'permits for movements' by the HA are a major consideration before the physical capability to deliver these components are undertaken.
- In critical areas, where modifications are required, the road construction must be formed to the minimum specification contained in the Turbine Manufactures Transport Guidance Notes.
- The Turbine Manufactures Transport Guidance Notes will state the minimum road width required for the transport of components. Any roads below this stated width will require widening to reflect this regardless of any swept path analysis not indicating modifications.
- The information is privileged and confidential and is for the exclusive use of the nominated client.
- All dimensions in meters

Road signs to be removed  
Trees to be pruned

- Area within red outline will be swept by tractor and trailer axles
- ▨ Hatched area within red outline to be levelled and prepared to accept axle loadings
- Area within magenta outline will be oversailed by load and projections
- Area within green outline will be oversailed by trailer body



**COLLETT & SONS LIMITED**  
Victoria Terminal TEL: +44(0)8456 255288  
Albert Road FAX: +44(0)8456 255244  
Halifax, HX2 0DF WEB: www.collett.co.uk

DRAWN	S.MANGHAM	TITLE	A47/NORWICH ROAD ROUNDABOUT	
DATE	20/03/2018	MAPPING	ORDNANCE SURVEY <small>Not Adjusted</small>	CUSTOMER
SCALE	1:500	SIZE	A3	PINCH POINT IDENTIFIED BY
			COLLETT	SITE
			NORFOLK VANGUARD	DWG. NO
				314597-180A1.1



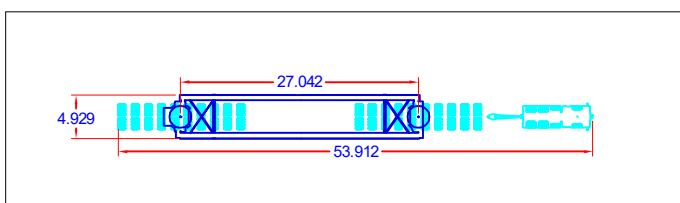

Swept Path indicates trailer utilising MANUAL steering

20 Row Girder Bridge Arrangement for the movement of a 200Te Transformer

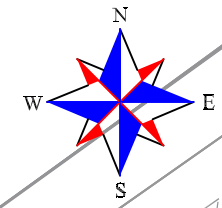

Continue on A47 to proposed site entrance.

**\*\*Caution\*\***

- Proposed junction alignment can be navigated utilising manual steering.

UK Grid Reference: TF 89245 11382

- The swept path analysis provided is produced from a purely transport orientated view, and does not consider any political issues in terms of land ownership, or any other precincts raised, that may otherwise be restrictive.
- The drawing has been produced from data created by Collett. A site visit has not been conducted to verify road widths or the presence of street furniture.
- All swept path diagrams and assessments are made and calculated for the road movement of loaded trailer equipment carrying Turbine components. These dimensions are based on the turning circles and specification of Collett & Sons Ltd trailer equipment.
- This SPA is a means of providing evidence of minimum requirements of any one vehicle as a footprint and there is no safety factor or margin included.
- Turbine delivery vehicles can be both left and right hand drive vehicles, therefore due to drivers perception it must be assumed that every vehicle will not follow the exact same line and so a margin of additional space should be allowed for.
- Land take is usually referred to when land is required from Private Land Owners; road widening is usually referred to when land is required within highways boundaries. The boundaries between private land and highways property are assumed by using obvious demarcation such as fence lines/hedges etc. It should be noted that actual boundaries between highways and private land are not substantiated in this report and can only be authenticated by carrying out land searches.
- Police escorts and permits will be required for the movement of all of the components. Form 'BE16' permits will also be required to undertake the movement of the vehicle shown in the swept path analysis. These permits are at the discretion of the Highway Agency (HA). Therefore, approval of these 'permits for movements' by the HA are a major consideration before the physical capability to deliver these components are undertaken.
- In critical areas, where modifications are required, the road construction must be formed to the minimum specification contained in the Turbine Manufacturers Transport Guidance Notes.
- The Turbine Manufacturers Transport Guidance Notes will state the minimum road width required for the transport of components. Any roads below this stated width will require widening to reflect this regardless of any swept path analysis not indicating modifications.
- The information is privileged and confidential and is for the exclusive use of the nominated client.
- All dimensions in meters

- Area within red outline will be swept by tractor and trailer axles
- Hatched area within red outline to be levelled and prepared to accept axle loadings
- Area within magenta outline will be oversailed by load and projections
- Area within green outline will be oversailed by trailer body

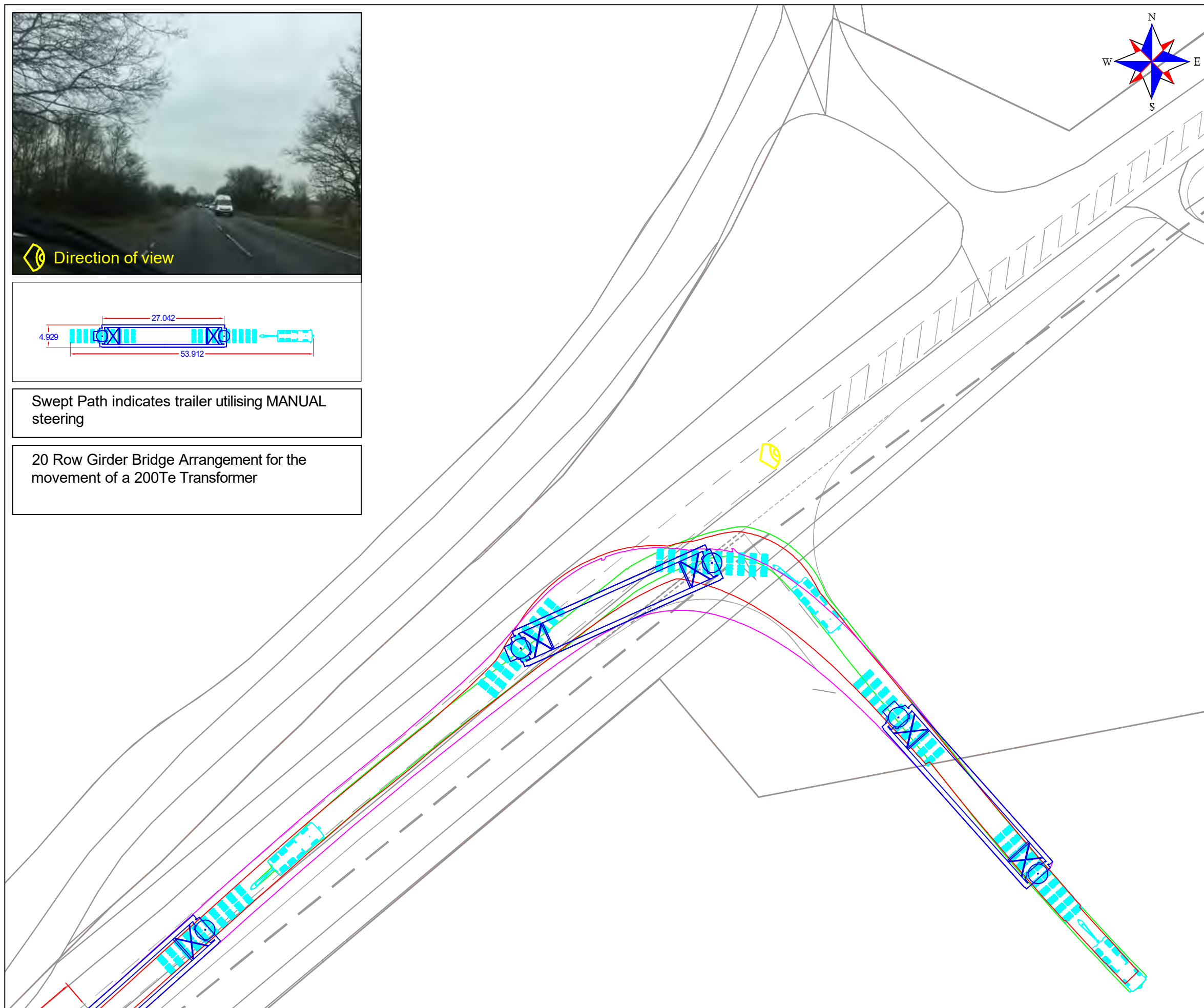

	<b>COLLETT &amp; SONS LIMITED</b> Victoria Terminal TEL: +44(0)8456 255288 Albert Road FAX: +44(0)8456 255244 Halifax, HX2 0DF WEB: www.collett.co.uk	DRAWN S.MANGHAM DATE 20/03/2018 SCALE 1:500	TITLE MAPPING PROVIDED BY CLIENT SIZE A3	<b>PROPOSED SITE ENTRANCE OFF A47</b> CUSTOMER ROYAL HASKONING DHV SITE NORFOLK VANGUARD PINCH POINT IDENTIFIED BY COLLETT DWG. NO 314597-190A1.1
--	--	---	--	---

## APPENDIX 3 - COUNCIL CORRESPONDENCE AND COMMENTS

<b>Our Ref:</b>	314597	<b>Date:</b>	10 <sup>th</sup> March 2018
-----------------	--------	--------------	-----------------------------

**Application for 'Confirmation of suitable route' for Norfolk Vanguard.**

To Whom it May Concern,

I am currently carrying out a survey to a site called 'Norfolk Vanguard', off A47 near Necton.

Could you please **confirm in writing** that the **route** detailed below and all structures that are involved in your area on this route are suitable in terms of axle loadings, spacing and Gross vehicle weights, in connection with the loaded vehicle specifications below.

<b>Route:</b>
<ul style="list-style-type: none"> <li>• Exit Kings Lynn Harbour onto Edward Benerfer Way,</li> <li>• Continue on Edward Benerfer Way to merge onto Grimston Road A148.</li> <li>• Continue on A148 to roundabout junction with A149 Queen Elizabeth Way,</li> <li>• At roundabout turn right onto A149 Queen Elizabeth Way,</li> <li>• Continue on A149 through 2 roundabouts to roundabout junction with A47,</li> <li>• At roundabout turn left onto A47,</li> <li>• At roundabout turn left onto A47,</li> <li>• At roundabout, continue on A47,</li> <li>• At roundabout continue on A47,</li> <li>• Continue on A47 to proposed site entrance on the right hand side at approx. OS Grid refs: TF 89245 11382.</li> </ul>

<b>Load A: Girder Bridge Only</b>									
Rigid Length	27.042	Overall Length	49.70	Overall Width	7.39	Overall Height	4.929	Gross Vehicle Weight	332.86Te

	<b>1</b>	<b>2</b>	<b>3</b>	<b>4</b>	<b>5</b>	<b>6</b>	<b>7</b>	<b>8</b>	<b>9</b>	<b>10</b>	<b>11</b>	<b>12</b>	<b>13</b>	
<b>Number of wheels per axle</b>	8	8	8	8	8	8	8	8	8	8	8	8	8	
<b>Axle Weight (Te.)</b>	16.64	16.64	16.64	16.64	16.64	16.64	16.64	16.64	16.64	16.64	16.64	16.64	16.64	
<b>Axle Spacing</b>		1.50	1.50	1.50	1.50	1.50	1.50	1.50	1.50	1.50	11.78	1.50	1.50	1.50

# COLLETT

EXPERTS IN MOTION

Victoria Terminal  
Albert Road  
HALIFAX  
West Yorkshire  
HX2 0DF

Mistral Point  
AW Nielsen Road  
GOOLE  
East Yorkshire  
DN14 6UE

Baltic House  
Central Dock Road  
GRANGEMOUTH  
Central Scotland  
FK3 8TY

Tel. +44 (0) 8456 255 233  
Fax +44 (0) 8456 255 244  
Email info@collett.co.uk

[www.collett.co.uk](http://www.collett.co.uk)

<b>14</b>	<b>15</b>	<b>16</b>	<b>17</b>	<b>18</b>	<b>19</b>	<b>20</b>
8	8	8	8	8	8	8
16.64	16.64	16.64	16.64	16.64	16.64	16.64
1.50	1.50	1.50	1.50	1.50	1.50	



Should there be any problem with any part of the route detailed, I would appreciate your immediate response.

Your urgent response would be greatly appreciated.  
Many thanks & best regards

Steven Mangham

**COLLETT & SONS LTD**



## Map of Routes

### Route A

#### Exit from Kings Lynn Harbour on Edward Benefer Way.



#### Continue on Edward Benefer Way to merge on Grimston Road A148.

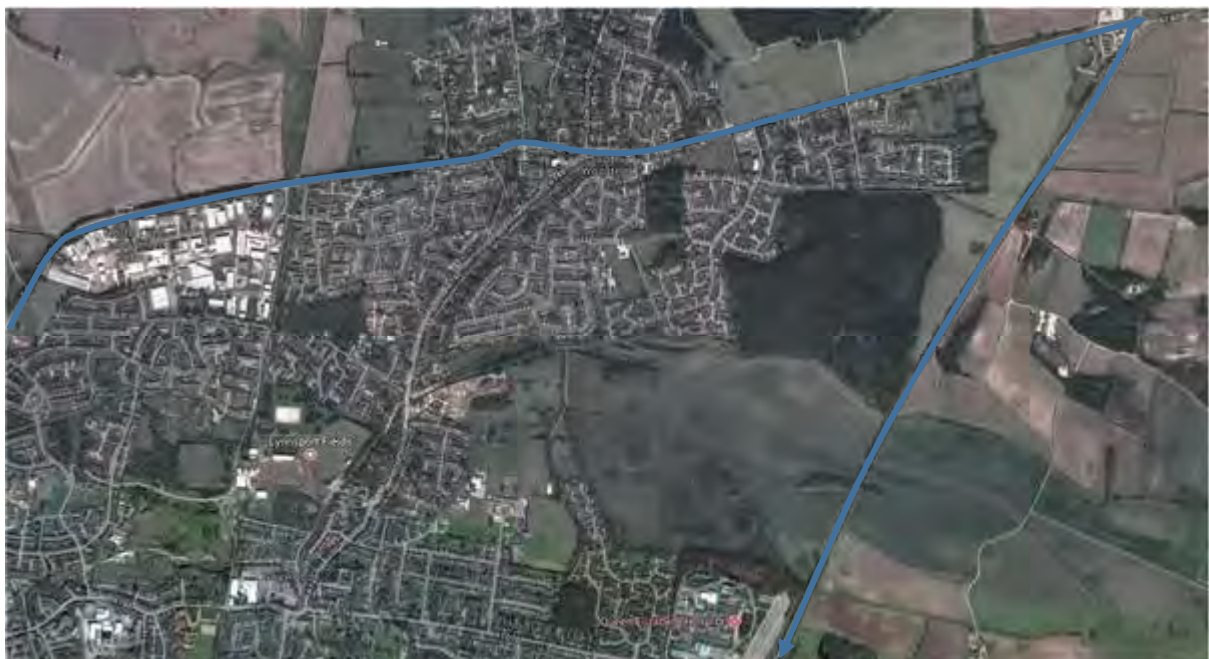



**Continue on A148 to roundabout junction with A47.**



**Continue on A47 to Site**

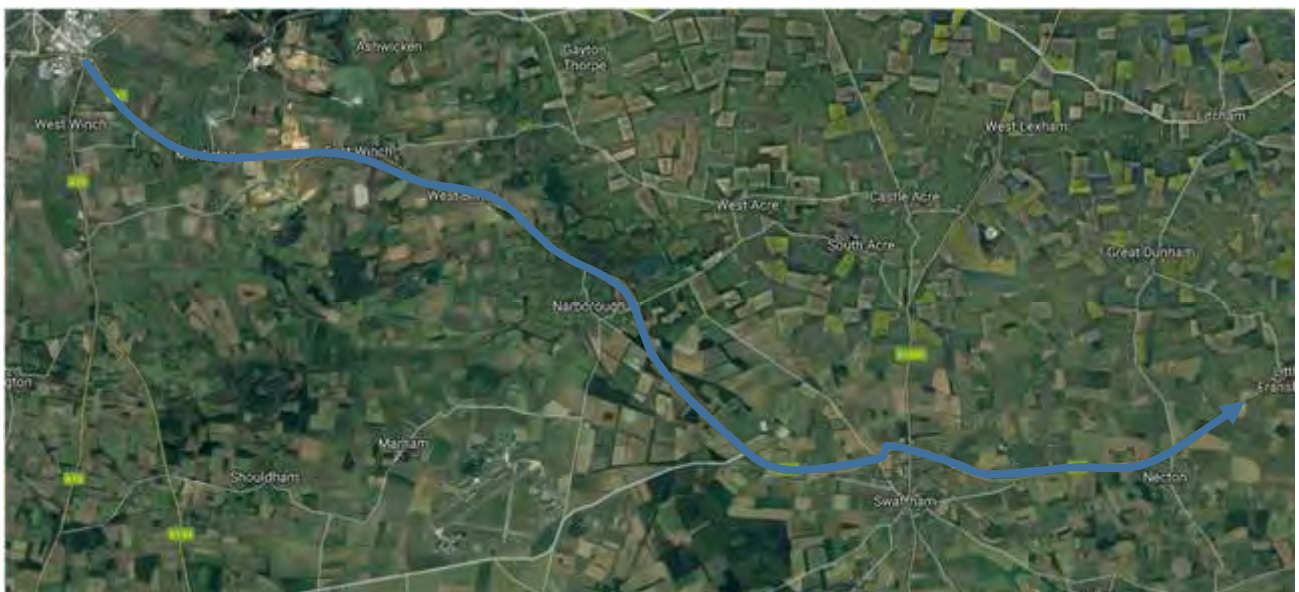

## Steven Mangham

---

**From:** Howell, Tania <Tania.Howell@jacobs.com>  
**Sent:** 21 March 2018 08:19  
**To:** Steven Mangham  
**Subject:** RE: Confirmation of Suitable Route - 314597

Good morning Steven,

Thank you for your enquiry.

I can confirm that neither of the route options will affect any Historic Railways Estate structures.

Regards  
Tania

Tania Howell  
Abnormal Loads Officer  
Jacobs  
DDI: 0118 946 8911

If your mail concerns abnormal load movements, please reply to [RSGBRB@jacobs.com](mailto:RSGBRB@jacobs.com)

---

**From:** Steven Mangham [<mailto:Steven.Mangham@collett.co.uk>]

**Sent:** 20 March 2018 16:54

**To:** [abloads.area6@kier.co.uk](mailto:abloads.area6@kier.co.uk); [roadspace.area6@kier.co.uk](mailto:roadspace.area6@kier.co.uk); [abnormalloads@norfolk.gov.uk](mailto:abnormalloads@norfolk.gov.uk); Abnormal Loads Contact ([AbnormalLoadsContact@networkrail.co.uk](mailto:AbnormalLoadsContact@networkrail.co.uk)) <[AbnormalLoadsContact@networkrail.co.uk](mailto:AbnormalLoadsContact@networkrail.co.uk)>; [abnormal.loads@canalrivertrust.org.uk](mailto:abnormal.loads@canalrivertrust.org.uk); [RSGBRB@jacobs.com](mailto:RSGBRB@jacobs.com)

**Subject:** [EXTERNAL] Confirmation of Suitable Route - 314597

Good Afternoon,

To Whom It May Concern:

Please find attached a Confirmation of Suitable Route request for Norfolk Vanguard.

Please note that, at present, we do not require a permit to move. This request is for information purposes only to ensure that the route is suitable to accept the axles loads proposed and to identify any potential structure issues there may be on the identified route.

If you could response in writing to [steven.mangham@collett.co.uk](mailto:steven.mangham@collett.co.uk) that would be much appreciated.

Kind Regards,

**Steven Mangham**

Consulting Team Manager/Renewables Project Manager

Collett & Sons Ltd | Victoria Terminal | Albert Road | Halifax | HX2 0DF | UK  
Tel: +44 (0)8456 255288 | Fax: +44 (0)8456 255244 | Mob: +44 (0)7852 040509  
Email: [steven.mangham@collett.co.uk](mailto:steven.mangham@collett.co.uk) | Web: [www.collett.co.uk](http://www.collett.co.uk)



TRANSPORT • HEAVY LIFT • MARINE • CONSULTING  
HALIFAX | GOOLE | GRANGEMOUTH  
[www.collett.co.uk](http://www.collett.co.uk)

---

NOTICE - This communication may contain confidential and privileged information that is for the sole use of the intended recipient. Any viewing, copying or distribution of, or reliance on this message by unintended recipients is strictly prohibited. If you have received this message in error, please notify us immediately by replying to the message and deleting it from your computer.

---

Jacobs U.K. Limited  
1180 Eskdale Road, Winnersh, Wokingham RG41 5TU  
Registered in England and Wales under number 2594504



## Steven Mangham

---

**From:** Administrator  
**Sent:** 26 March 2018 12:11  
**To:** Steven Mangham  
**Subject:** FW: 2018-03-23 00-00 Confirmation\_of\_suitable\_route\_314597  
**Attachments:** 2018-03-23 00-00 Confirmation\_of\_suitable\_route\_314597.pdf; 2018-03-23 00-00 Confirmation\_of\_suitable\_route\_314597.xlsx

**Michael Collett**  
Director

Collett & Sons Ltd | Victoria Terminal | Albert Road | Halifax | HX2 0DF | UK  
Tel: +44 (0)8456 255233 | Fax: +44 (0)8456 255244 | mob: 07917 136146

**COLLETT**  
EXPERTS IN MOTION

TRANSPORT • HEAVY LIFT • MARINE • CONSULTING  
HALIFAX | GOOLE | GRANGEMOUTH  
[www.collett.co.uk](http://www.collett.co.uk)

Goods are accepted for carriage, lifting, storage, fulfilment and transport subject to the RHA, CMR, CPA, and BIFA Terms & Conditions. Copies of which are available from our website: <http://www.collett.co.uk/index.php/sheq/accreditations-and-terms-conditions>

---

**From:** Hughes, John [<mailto:John.Hughes@kier.co.uk>]  
**Sent:** 26 March 2018 11:59  
**To:** info at collett  
**Cc:** Nick Hyde ([Nicolas.hyde@highwaysengland.co.uk](mailto:Nicolas.hyde@highwaysengland.co.uk)); Chimwemwe Banda  
**Subject:** 2018-03-23 00-00 Confirmation\_of\_suitable\_route\_314597

Steven Mangham  
Proposals such as in the attached have to be dealt with by due process.  
If you have not already done so you must submit a Special Order Notification to:-

Abnormal Loads  
Highways England | The Cube | 199 Wharfside Street | Birmingham | B1 1RN  
**Tel:** 0300 470 3102  
**Abnormal Loads Team Tel:** 0300 470 3004  
Web: <http://www.highways.gov.uk>

I believe that this is done via [ESDAL](#).

There are potentially twenty structures belonging to Highways England that may be affected by your proposal, though I note that you are avoiding some of the larger span structures in your attached proposal.

The structures potentially affected by your proposal are listed in the attached excel spreadsheet. We at Kier are unable to process your proposal further without a notification and Special Order reference from Highways England.

Regards

John Hughes Bsc. C.Eng MICE

Project Manager Structures  
Abnormal Loads Coordinator Highways England Areas 6 and 8

**Kier Services | Highways** | Sandy Highways Depot, Beamish Close, Sandy **SG19 1SD**  
T: | 01223 255255 | E: [john.hughes@kier.co.uk](mailto:john.hughes@kier.co.uk)  
Web [www.kier.co.uk](http://www.kier.co.uk)

**Connect with us** | follow us on [LinkedIn](#) | like us on [Facebook](#) | follow us on [Twitter](#) | follow us on [Google+](#) | follow us on [Instagram](#)  
Our values are enthusiastic, collaborative and forward-thinking

Kier Highways Limited | Registered in England No. 5606089  
Registered Office: Tempsford Hall, Sandy, Bedfordshire, SG19 2BD

## Steven Mangham

---

**From:** Nicholson Katie <Katie.Nicholson@networkrail.co.uk> on behalf of Network Rail Abnormal Loads <NetworkRailAbnormalLoads@networkrail.co.uk>  
**Sent:** 23 March 2018 13:20  
**To:** Steven Mangham  
**Subject:** QID 615 RE: Confirmation of Suitable Route - 314597

Hi Steven,

Your proposed movement does not affect any Network Rail owned road over rail bridges or tunnels therefore we have no objection to your proposed routes.

Please note we only check the load carrying capacity of Network Rail owned road over rail bridges affected we do not check anything else including:

- Load carrying capacity of level crossings
- Clearance to bridge parapets
- Clearance under a rail bridge
- Clearance to overhead wires at level crossings

### Many Thanks

#### Katie Nicholson

Abnormal Loads Assistant  
Abnormal Loads Help Desk: 01908 783 140



Abnormal Loads | National Records Group | Route Services

The Quadrant | Elder Gate | Milton Keynes | MK9 1EN

D 01908 783 140 | E [Katie.Nicholson@networkrail.co.uk](mailto:Katie.Nicholson@networkrail.co.uk) W [Network Rail Abnormal Loads](#)

---

**From:** Steven Mangham [<mailto:Steven.Mangham@collett.co.uk>]

**Sent:** 20 March 2018 16:53

**To:** [abloads.area6@kier.co.uk](mailto:abloads.area6@kier.co.uk); [roadspace.area6@kier.co.uk](mailto:roadspace.area6@kier.co.uk); [abnormalloads@norfolk.gov.uk](mailto:abnormalloads@norfolk.gov.uk); Network Rail Abnormal Loads; [abnormal.loads@canalrivertrust.org.uk](mailto:abnormal.loads@canalrivertrust.org.uk); [rsgbrb@jacobs.com](mailto:rsgbrb@jacobs.com)

**Subject:** Confirmation of Suitable Route - 314597

Good Afternoon,

To Whom It May Concern:

Please find attached a Confirmation of Suitable Route request for Norfolk Vanguard.

Please note that, at present, we do not require a permit to move. This request is for information purposes only to ensure that the route is suitable to accept the axles loads proposed and to identify any potential structure issues there may be on the identified route.

If you could response in writing to [steven.mangham@collett.co.uk](mailto:steven.mangham@collett.co.uk) that would be much appreciated.

Kind Regards,

**Steven Mangham**

Consulting Team Manager/Renewables Project Manager

Collett & Sons Ltd | Victoria Terminal | Albert Road | Halifax | HX2 0DF | UK  
Tel: +44 (0)8456 255288 | Fax: +44 (0)8456 255244 | Mob: +44 (0)7852 040509  
Email: [steven.mangham@collett.co.uk](mailto:steven.mangham@collett.co.uk) | Web: [www.collett.co.uk](http://www.collett.co.uk)



\*\*\*\*\*  
\*\*\*\*\*

The content of this email (and any attachment) is confidential. It may also be legally privileged or otherwise protected from disclosure.  
This email should not be used by anyone who is not an original intended recipient, nor may it be copied or disclosed to anyone who is not an original intended recipient.

If you have received this email by mistake please notify us by emailing the sender, and then delete the email and any copies from your system.

Liability cannot be accepted for statements made which are clearly the sender's own and not made on behalf of Network Rail.  
Network Rail Infrastructure Limited registered in England and Wales No. 2904587, registered office Network Rail, 2nd Floor, One Eversholt Street, London, NW1 2DN

\*\*\*\*\*  
\*\*\*\*\*



## Steven Mangham

---

**From:** ETD Bridges <pandt.bridges@norfolk.gov.uk>  
**Sent:** 21 March 2018 12:15  
**To:** Steven Mangham  
**Subject:** RE: MOVING - NO DATE FW: Confirmation of Suitable Route - 314597  
ABNORMAL LOAD

Hi Steven

I have checked the routes and do not see any problems with the proposed vehicle/axle loads travelling over the NCC owned structures on the route. NCC are not responsible for the structures on the A47 and you will need to contact Highways England for them to comment on the suitability of that part of the route.

Regards

Mark

**Mark North**  
**Bridge Network Engineer**  
Highways & Transport  
Community and Environmental Services

Direct Dial Telephone No: 01603 223804  
Direct Fax No: 01603 223305  
E-mail: [mark.north@norfolk.gov.uk](mailto:mark.north@norfolk.gov.uk)

**Norfolk County Council**  
General enquiries: 0344 800 8020 or [information@norfolk.gov.uk](mailto:information@norfolk.gov.uk)  
Website: [www.norfolk.gov.uk](http://www.norfolk.gov.uk)

---

**From:** Abnormal Loads  
**Sent:** 21 March 2018 08:56  
**To:** ETD Bridges <pandt.bridges@norfolk.gov.uk>  
**Subject:** MOVING - NO DATE FW: Confirmation of Suitable Route - 314597 ABNORMAL LOAD

---

**From:** Steven Mangham [<mailto:Steven.Mangham@collett.co.uk>]  
**Sent:** 20 March 2018 16:53  
**To:** [abloads.area6@kier.co.uk](mailto:abloads.area6@kier.co.uk); [roadspace.area6@kier.co.uk](mailto:roadspace.area6@kier.co.uk); Abnormal Loads <[abnormalloads@norfolk.gov.uk](mailto:abnormalloads@norfolk.gov.uk)>;  
Abnormal Loads Contact ([AbnormalLoadsContact@networkrail.co.uk](mailto:AbnormalLoadsContact@networkrail.co.uk)) <[AbnormalLoadsContact@networkrail.co.uk](mailto:AbnormalLoadsContact@networkrail.co.uk)>;  
[abnormal.loads@canalrivertrust.org.uk](mailto:abnormal.loads@canalrivertrust.org.uk); [rsgbrb@jacobs.com](mailto:rsgbrb@jacobs.com)  
**Subject:** Confirmation of Suitable Route - 314597

Good Afternoon,

To Whom It May Concern:

Please find attached a Confirmation of Suitable Route request for Norfolk Vanguard.

Please note that, at present, we do not require a permit to move. This request is for information purposes only to ensure that the route is suitable to accept the axles loads proposed and to identify any potential structure issues there may be on the identified route.

If you could response in writing to [steven.mangham@collett.co.uk](mailto:steven.mangham@collett.co.uk) that would be much appreciated.

Kind Regards,

**Steven Mangham**

Consulting Team Manager/Renewables Project Manager

Collett & Sons Ltd | Victoria Terminal | Albert Road | Halifax | HX2 0DF | UK  
Tel: +44 (0)8456 255288 | Fax: +44 (0)8456 255244 | Mob: +44 (0)7852 040509  
Email: [steven.mangham@collett.co.uk](mailto:steven.mangham@collett.co.uk) | Web: [www.collett.co.uk](http://www.collett.co.uk)



--

To see our email disclaimer click here <http://www.norfolk.gov.uk/emaildisclaimer>

## 11 APPENDIX 4 PILOT VEHICLE CONCEPT

---



Legend

### STAGE 1: HGV WAITS TO BE CALLED

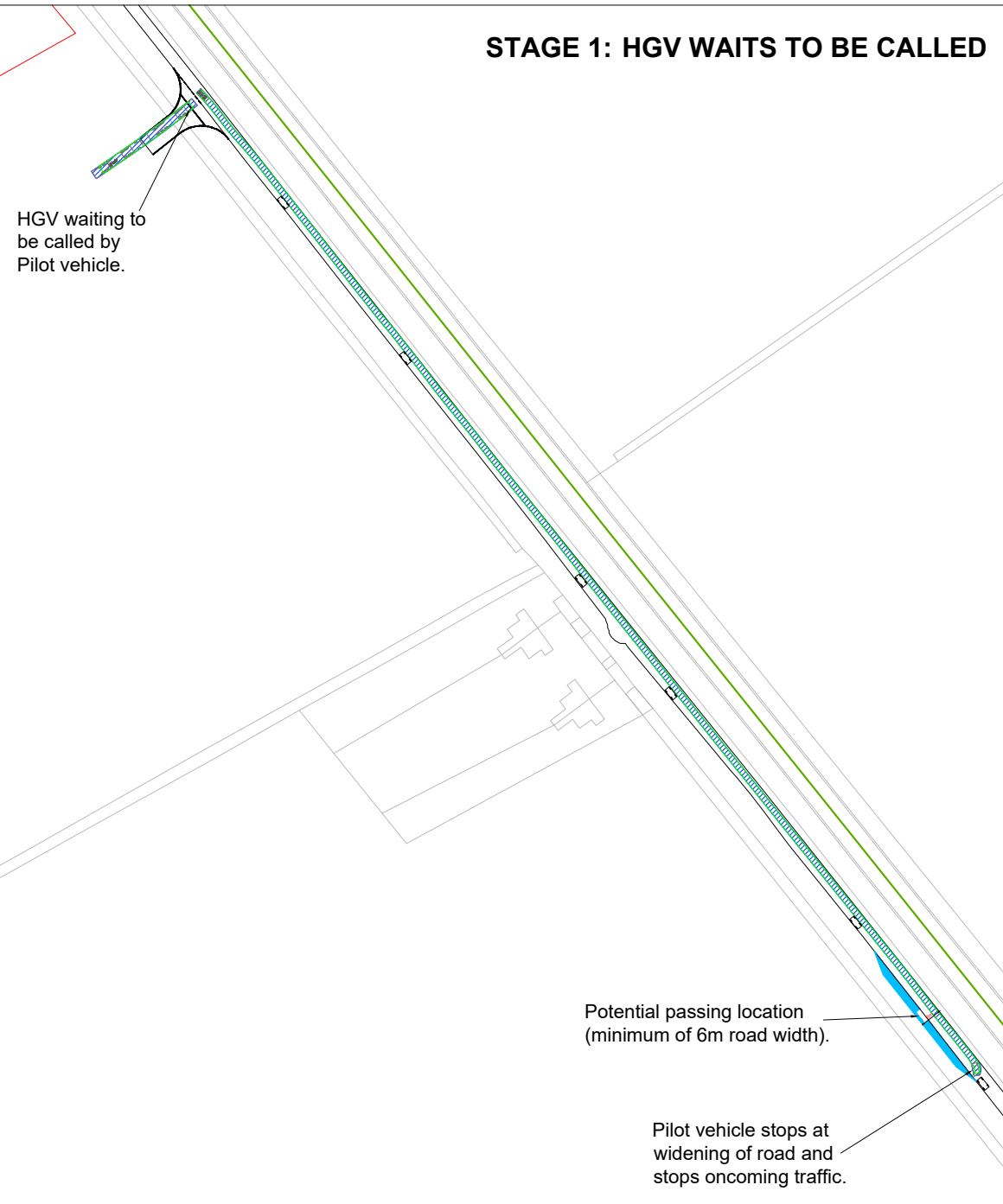

### STAGE 2: HGV TRAVELS TO DESIGNATED PASSING PLACE

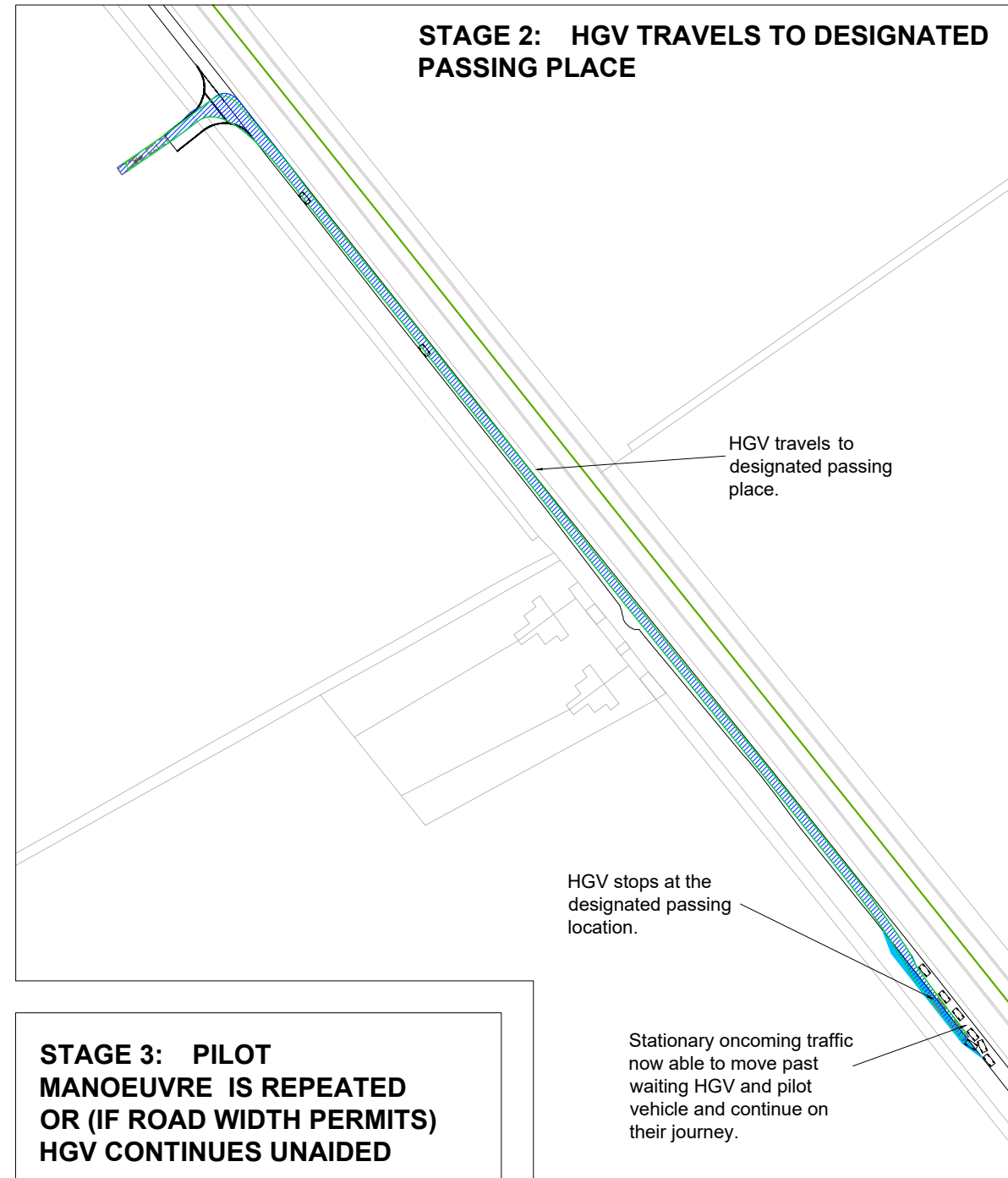

### STAGE 3: PILOT MANOEUVRE IS REPEATED OR (IF ROAD WIDTH PERMITS) HGV CONTINUES UNAIDED

**PROJECT:**  
**NORFOLK VANGUARD OFFSHORE WIND FARM**

**TITLE:**  
**PILOT VEHICLE WITH PASSING PLACES**

Rev	Date	By	Comment

Drg No	TP-PB47476-DR011
Rev	D0.1
Date	02.05.18
Layout	LAYOUT



## 12 APPENDIX 5 B1149 TRAFFIC MANAGEMENT

---

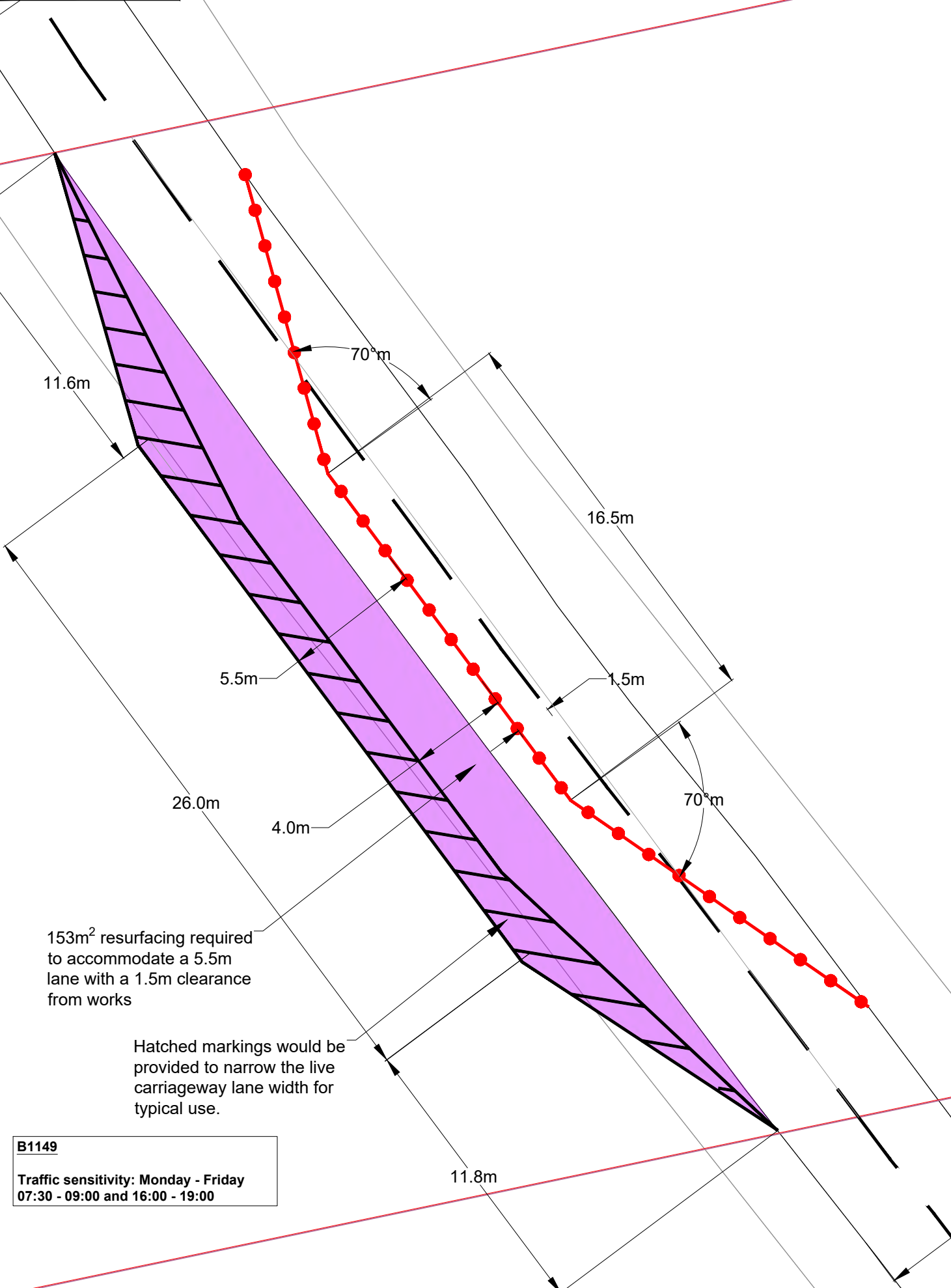

**B1149**  
Traffic sensitivity: Monday - Friday  
07:30 - 09:00 and 16:00 - 19:00

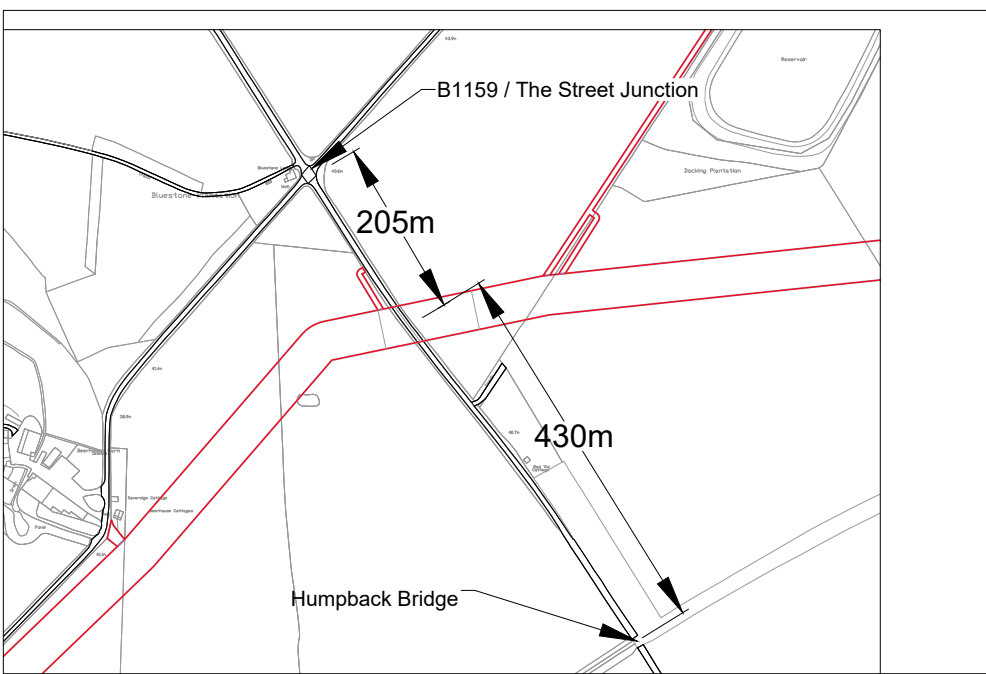

Plan SC7: Portable traffic signals on a two-lane single carriageway road

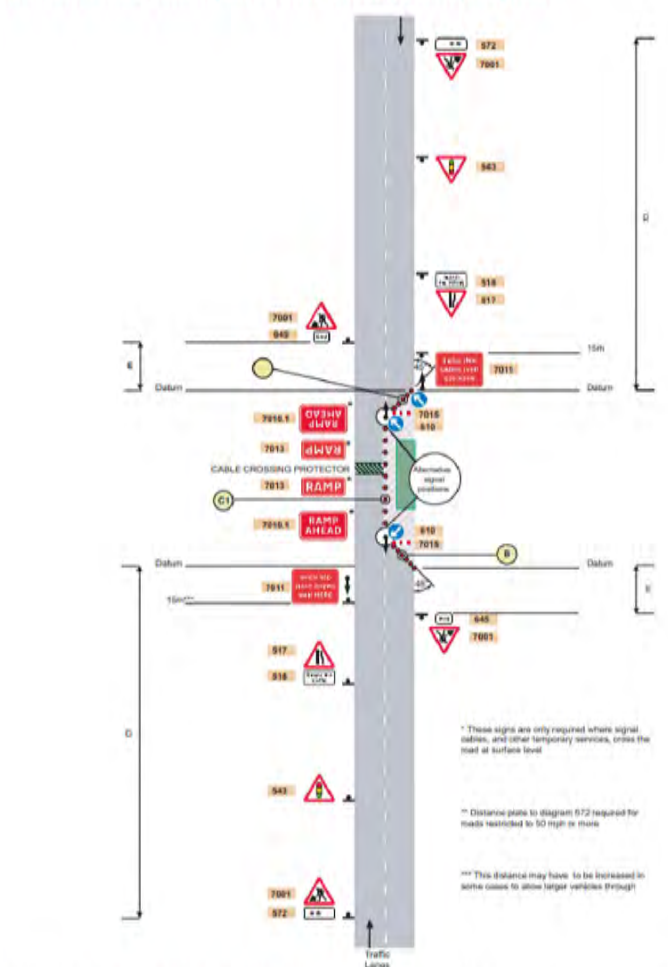

NOTE: Refer to Table 5.3 in Section D5.4 for recommended range of distances for dimensions D and E.

Table 5.3 Distances shown in plans in Sections D5.5 to D5.8 and D5.10

	Single carriageway road: Permanent speed limit			
	30 mph or less	40 mph	50 mph	Unrestricted (60 mph)
Minimum and normal maximum stopping distance D of first sign in advance of lead-in taper in metres	20 - 45	45 - 110	275 - 450	275 - 450
Minimum longitudinal clearance L in metres	0.5	15	30	60
Length of taper T in metres:				
1	15	20	25	25
2	26	40	50	50
3	39	60	75	75
4	52	80	100	100
5	65	100	125	125
Minimum lateral safety zone clearance	0.5	0.5	1.2	1.2
Distance E to "end of road works" sign	10 - 30	10 - 30	30 - 45	30 - 45

Extracts from Traffic Signs Manual (2009)  
Chapter 8 Part 1

**NOTES**  
1. Do not scale from this drawing, all dimensions are in metres unless noted otherwise.  
2. This drawing has been based upon Ordnance Survey Maps and Royal Haskoning can not guarantee the accuracy of data.  
3. This drawing is an update to PB4476-DR033, first issued in the Norfolk Vanguard DCO application.

**KEY**  
 DCO ORDER LIMITS  
 REQUIRED RESURFACING  
 INDICATIVE CONES

F1.0	FIRST ISSUE				
REV	DATE	DESCRIPTION	BY	CHK	APP

REVISIONS

CLIENT



PROJECT  
**NORFOLK BOREAS  
OFFSHORE WIND FARM**

TITLE  
**B1149 TRAFFIC MANAGEMENT  
(SOUTH WESTERN VERGE)**



DRAWN	RNE	CHECKED	ADR	APPROVED	ADR
DATE	23.01.20	SCALE AT A1	1:250	CLIENTS REF.	

DRAWING No. TP-PB5640-DR023  
REVISION F1.0

DRAWING No. TP-PB4476-DR024

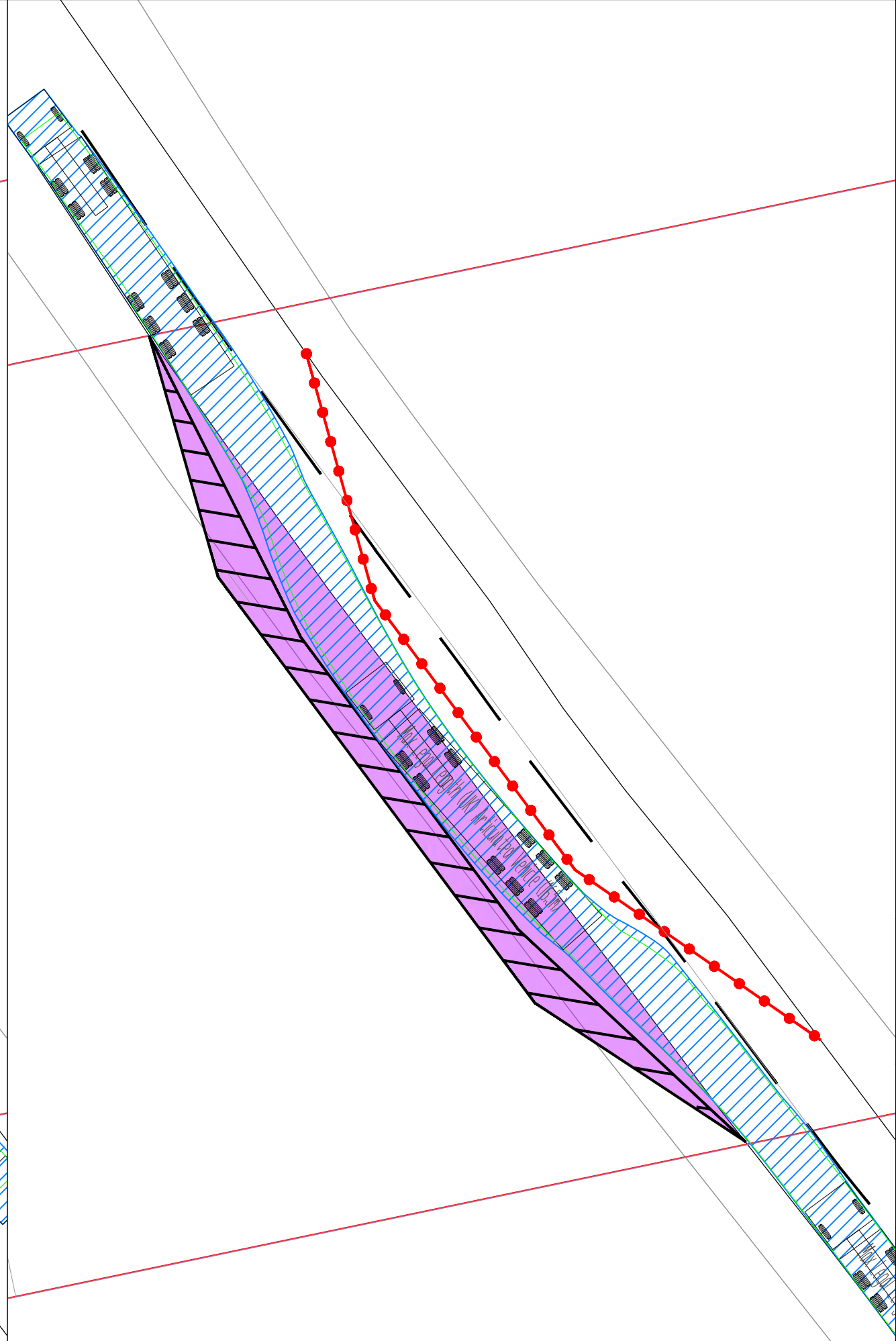
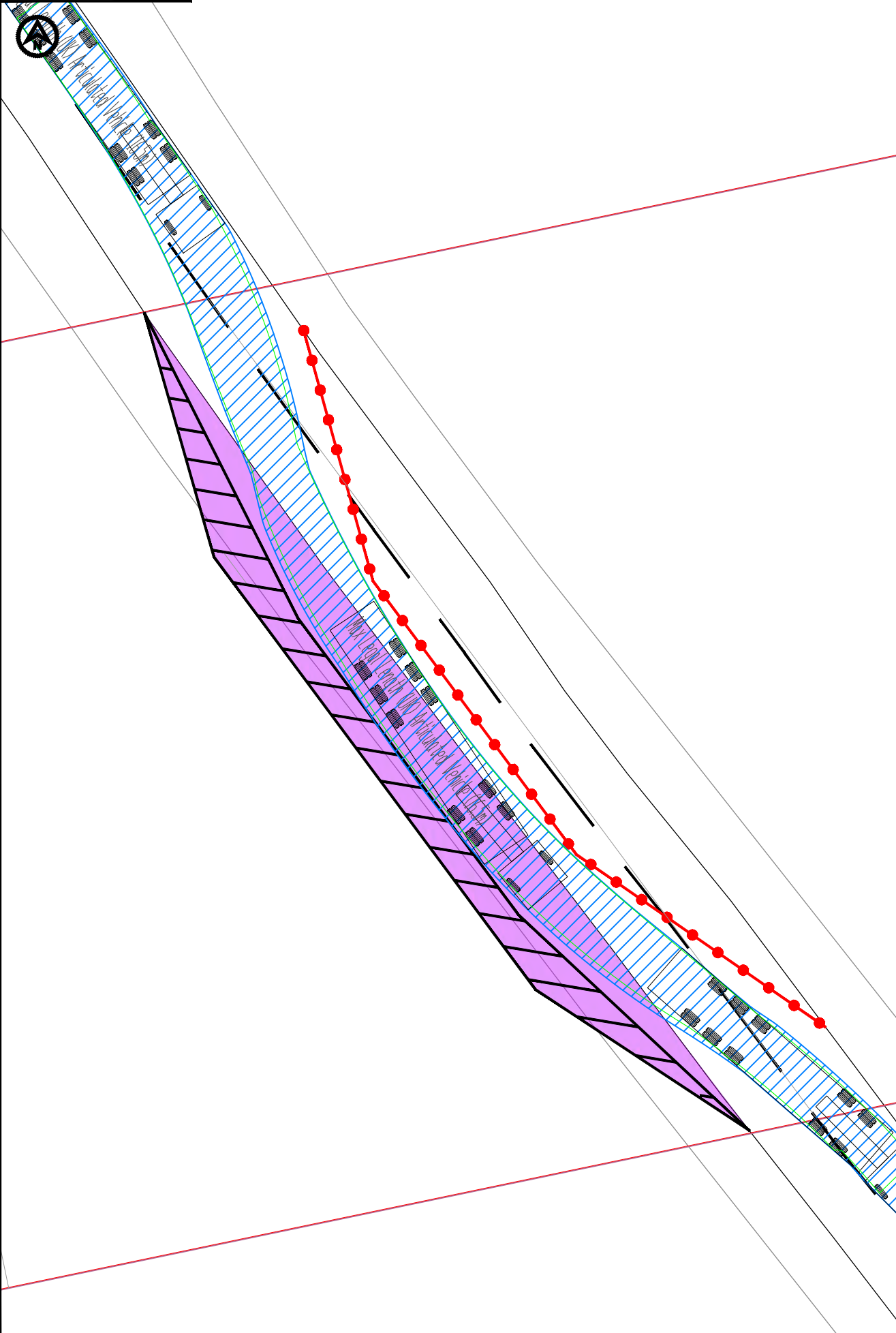

**NOTES**  
 1. Do not scale from this drawing, all dimensions are in metres unless noted otherwise.  
 2. This drawing has been based upon Ordnance Survey Maps and Royal Haskoning can not guarantee the accuracy of data.  
 3. This drawing is an update to PB4476-DR034, first issued in the Norfolk Vanguard DCO application.

**KEY**  
 ORDER LIMITS

**VEHICLE TRACKING**

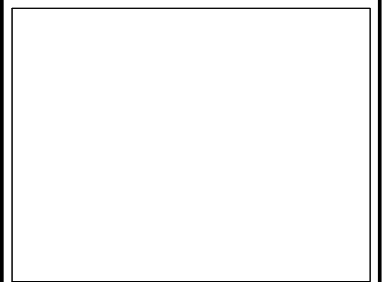

- VEHICLE BODY SWEEP PATH (FORWARD GEAR)
- VEHICLE CHASSIS SWEEP PATH
- REQUIRED RESURFACING
- INDICATIVE CONES

**DRAFT - NOT FOR CONSTRUCTION**

REV	DATE	DESCRIPTION	BY	CHK	APP
F1.0		FIRST ISSUE			

REVISIONS

CLIENT



PROJECT  
 NORFOLK BOREAS OFFSHORE WIND FARM

TITLE  
 B1149 TRAFFIC MANAGEMENT ARTICULATED LORRY SWEEP PATH ANALYSIS (SOUTH WESTERN VERGE)



DRAWN	RNE	CHECKED	ADR	APPROVED	ADR
DATE	23.01.20	SCALE AT A3	1:250	CLIENTS REF.	
DRAWING No.	TP-PB4476-DR024				REVISION
CLIENT DWG No.					F1.0

REPRODUCED FROM ORDNANCE SURVEY MAPS WITH PERMISSION FROM THE CONTROLLER OF HM STATIONERY OFFICE. CROWN COPYRIGHT RESERVED. LICENCE No. 100023422 2007.

Southbound  
 SCALE - 1:250

Northbound  
 SCALE - 1:250



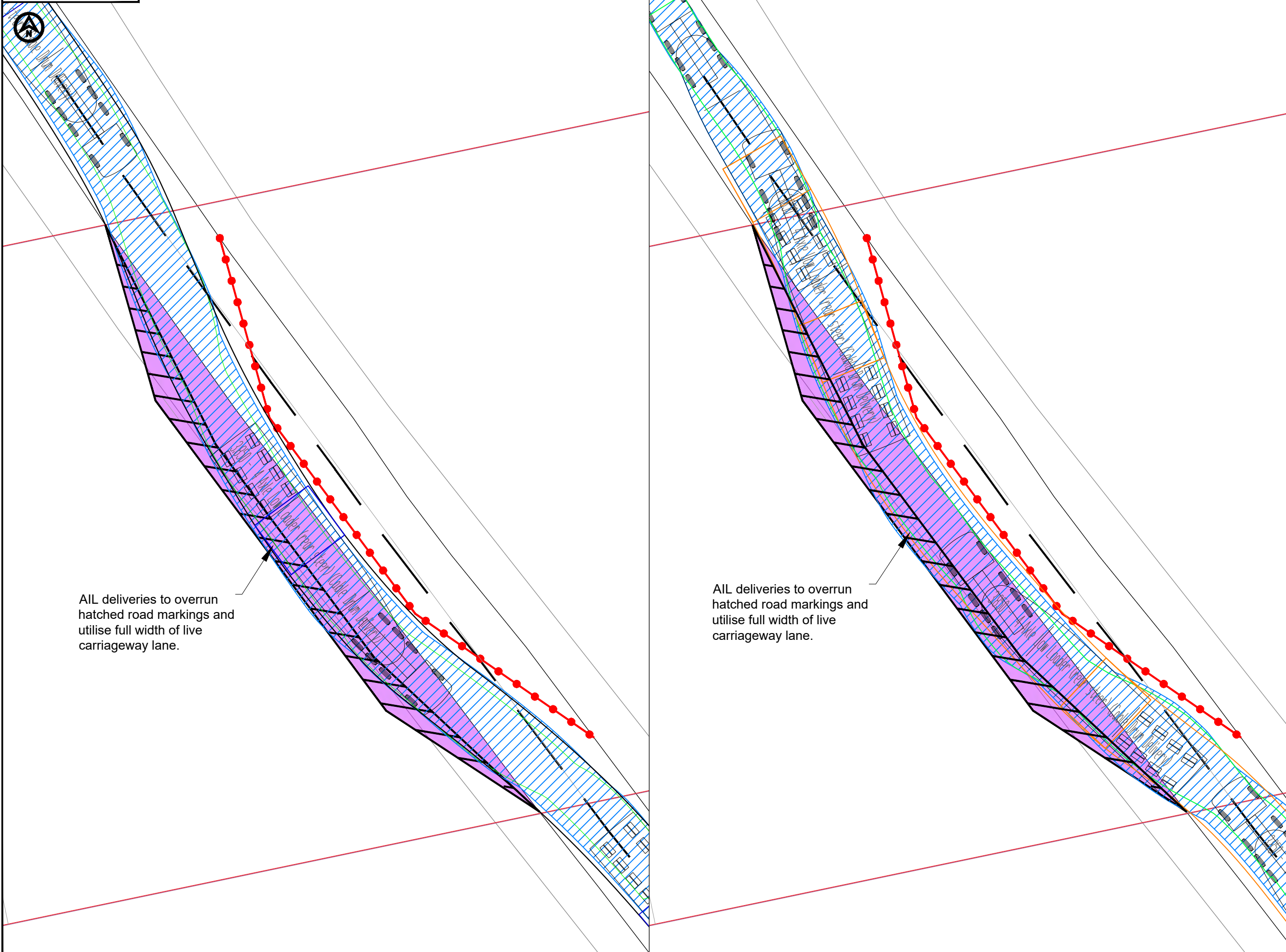

ALL deliveries to overrun hatched road markings and utilise full width of live carriageway lane.

ALL deliveries to overrun hatched road markings and utilise full width of live carriageway lane.

- NOTES**
- Do not scale from this drawing, all dimensions are in metres unless noted otherwise.
  - This drawing has been based upon Ordnance Survey Maps and Royal Haskoning can not guarantee the accuracy of data.
  - This drawing is an update to PB4476-DR035, first issued in the Norfolk Vanguard DCO application.
  - Cable drum dimensions taken from Hornsea 3 Offshore Wind Farm document 'Main Construction Compound Access Strategy' September 2018.
  - Typical ALL vehicle used suitable for cable drum loadings.

**KEY**

— ORDER LIMITS

**VEHICLE TRACKING**

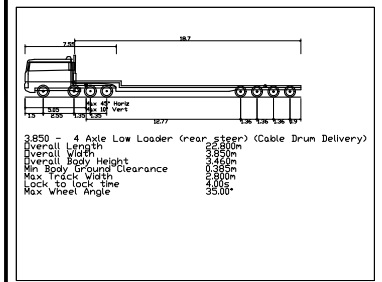

- VEHICLE BODY SWEEP PATH (FORWARD GEAR)
- VEHICLE CHASSIS SWEEP PATH
- INDICATIVE CABLE DRUM SWEEP PATH
- REQUIRED RESURFACING
- INDICATIVE CONES

**DRAFT - NOT FOR CONSTRUCTION**

D.01	FIRST ISSUE				
REV.	DATE	DESCRIPTION	BY	CHK.	APP.

REVISIONS

CLIENT

**VATTENFALL**

PROJECT

NORFOLK BOREAS OFFSHORE WIND FARM

TITLE

B1149 TRAFFIC MANAGEMENT  
TYPICAL AIL CABLE DRUM DELIVERY  
SWEPT PATH ANALYSIS  
(SOUTH WESTERN VERGE)

Royal HaskoningDHV  
Enhancing Society Together

DRAWN	RNE	CHECKED	ADR	APPROVED	ADR
DATE	23.01.20	SCALE AT A3	1:250	CLIENTS REF.	
DRAWING No.	TP-PB5640-DR025				REVISION
CLIENT DWG No.					F1.0



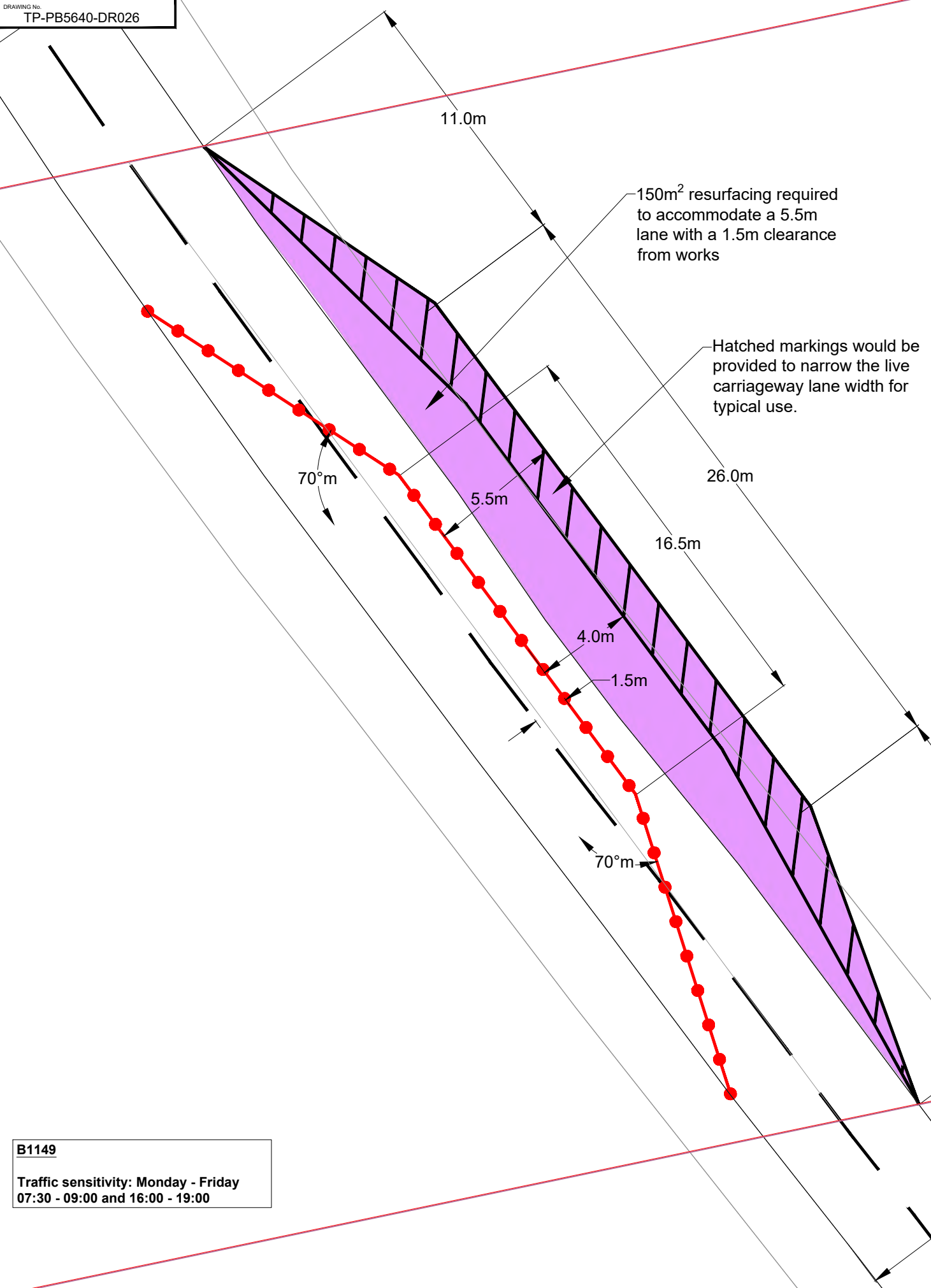

**B1149**  
 Traffic sensitivity: Monday - Friday  
 07:30 - 09:00 and 16:00 - 19:00

**B1149 - Cable Crossing**

© Vattenfall Wind Power Ltd 2019. Contains Ordnance Survey data  
 © Crown copyright and database rights 2019 Ordnance Survey 0100031673

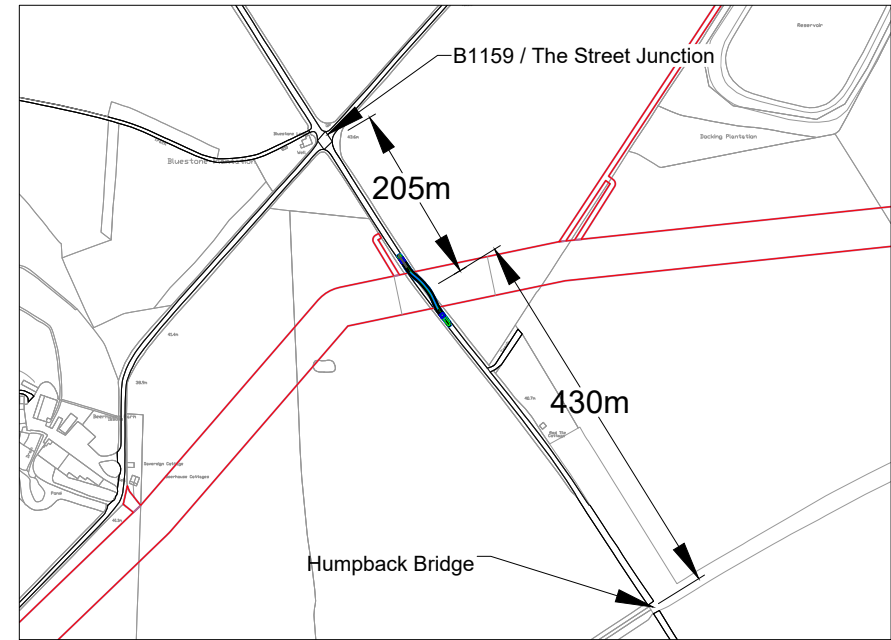

Plan SC7: Portable traffic signals on a two-lane single carriageway road

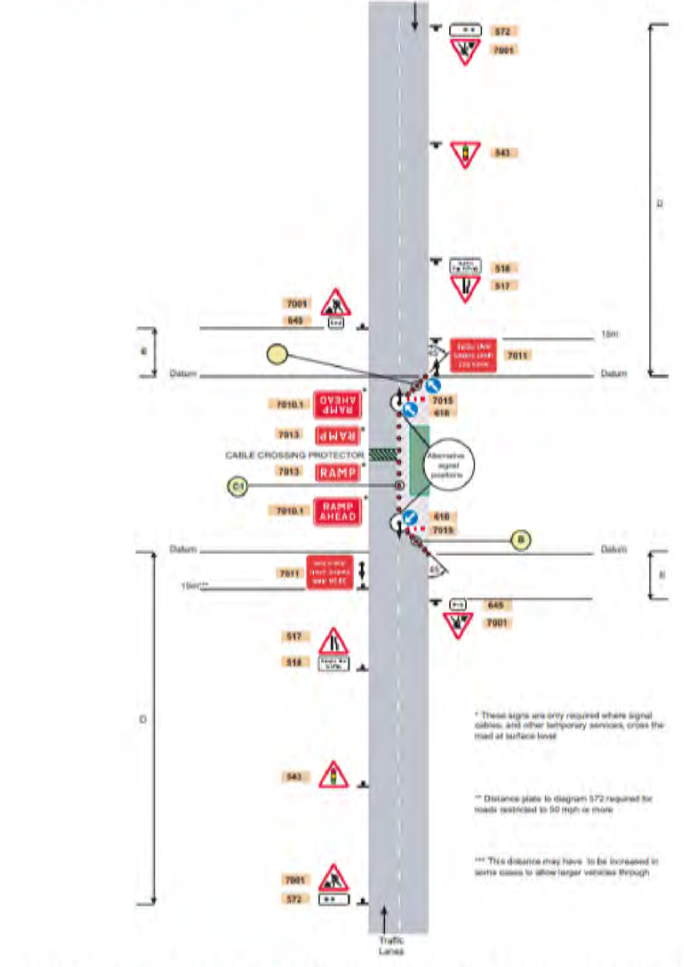

Extracts from Traffic Signs Manual (2009) Chapter 8 Part 1

	Single carriageway road: Permanent speed limit			
	30mph or less	40mph	50mph	Unrestricted (60mph)
Minimum and normal maximum sight distance D of first sign in advance of lead-in taper in metres	20* - 45	45 - 110	275 - 450	275 - 450
Minimum longitudinal clearance L in metres	0.5	15	30	60
Length of taper T in metres				
1	13	20	25	25
2	26	40	50	50
3	39	60	75	75
4	52	80	100	100
5	65	100	125	125
Minimum lateral safety zone clearance	0.5	0.5	1.2	1.2
Distance E to 'end of road works' sign	10 - 30	10 - 30	30 - 45	30 - 45

**NOTES**  
 1. Do not scale from this drawing, all dimensions are in metres unless noted otherwise.  
 2. This drawing has been based upon Ordnance Survey Maps and Royal Haskoning can not guarantee the accuracy of data.  
 3. This drawing is an update to PB4476-DR026, first issued in the Norfolk Vanguard DCO application.

**KEY**  
 DCO ORDER LIMITS  
 REQUIRED RESURFACING  
 INDICATIVE CONES

REV	DATE	DESCRIPTION	BY	CHK	APP
F1.0		FIRST ISSUE			

REVISIONS

CLIENT

**VATTENFALL**

PROJECT  
 NORFOLK BOREAS OFFSHORE WIND FARM

TITLE  
 B1149 TRAFFIC MANAGEMENT (NORTH EASTERN VERGE)

Royal HaskoningDHV  
 Enhancing Society Together

DRAWN	RNE	CHECKED	ADR	APPROVED	ADR
DATE	23.01.20	SCALE AT A1	1:250	CLIENTS REF.	
DRAWING No.	TP-PB5640-DR026				REVISION
					F1.0

DRAWING No. TP-PB5640-DR027

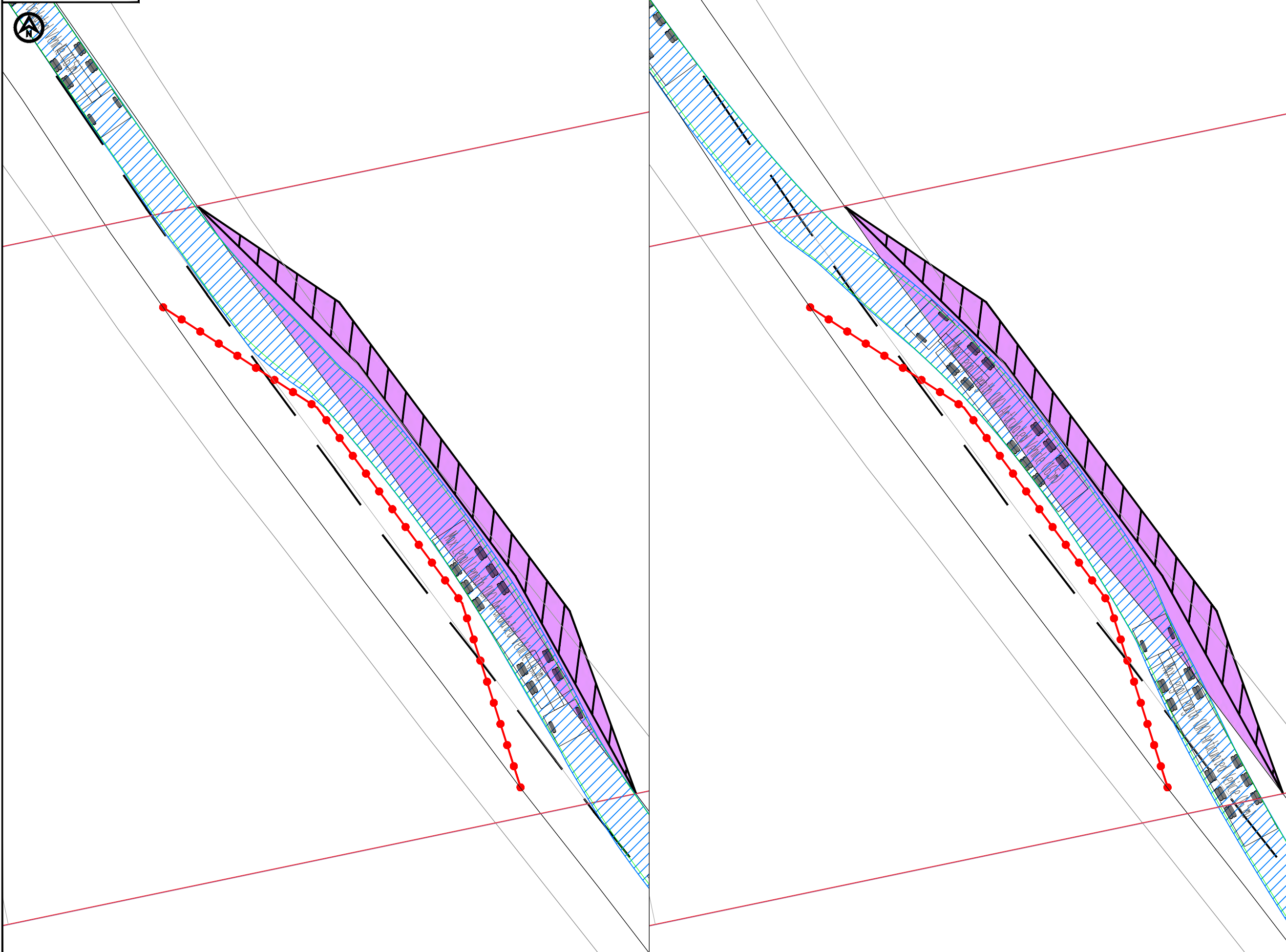

**NOTES**  
 1. Do not scale from this drawing, all dimensions are in metres unless noted otherwise.  
 2. This drawing has been based upon Ordnance Survey Maps and Royal Haskoning can not guarantee the accuracy of data.  
 3. This drawing is an update to PB4476-DR037, first issued in the Norfolk Vanguard DCO application.

**KEY**  
 ORDER LIMITS  
**VEHICLE TRACKING**

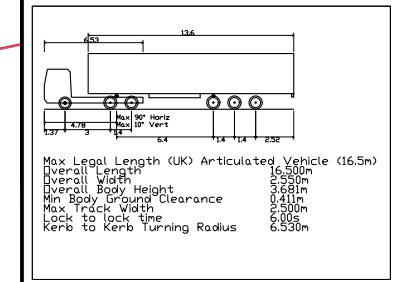

VEHICLE BODY SWEEP PATH (FORWARD GEAR)  
 VEHICLE CHASSIS SWEEP PATH  
 REQUIRED RESURFACING  
 INDICATIVE CONES

**DRAFT - NOT FOR CONSTRUCTION**

REV	DATE	DESCRIPTION	BY	CHK	APP
F1.0		FIRST ISSUE			

REVISIONS

CLIENT



PROJECT  
 NORFOLK BOREAS OFFSHORE WIND FARM

TITLE  
 B1149 TRAFFIC MANAGEMENT ARTICULATED LORRY SWEEP PATH ANALYSIS (NORTH EASTERN VERGE)



DRAWN	CHECKED	APPROVED
RNE	ADR	ADR
DATE: 23.01.20	SCALE AT A3: 1:250	CLIENTS REF.
DRAWING No. TP-PB5640-DR027	REVISION	F1.0
CLIENT DWG No.		

REPRODUCED FROM ORDNANCE SURVEY MAPS WITH PERMISSION FROM THE CONTROLLER OF HM STATIONERY OFFICE. CROWN COPYRIGHT RESERVED. LICENCE No. 100023422 2007.

Southbound  
 SCALE - 1:250

Northbound  
 SCALE - 1:250

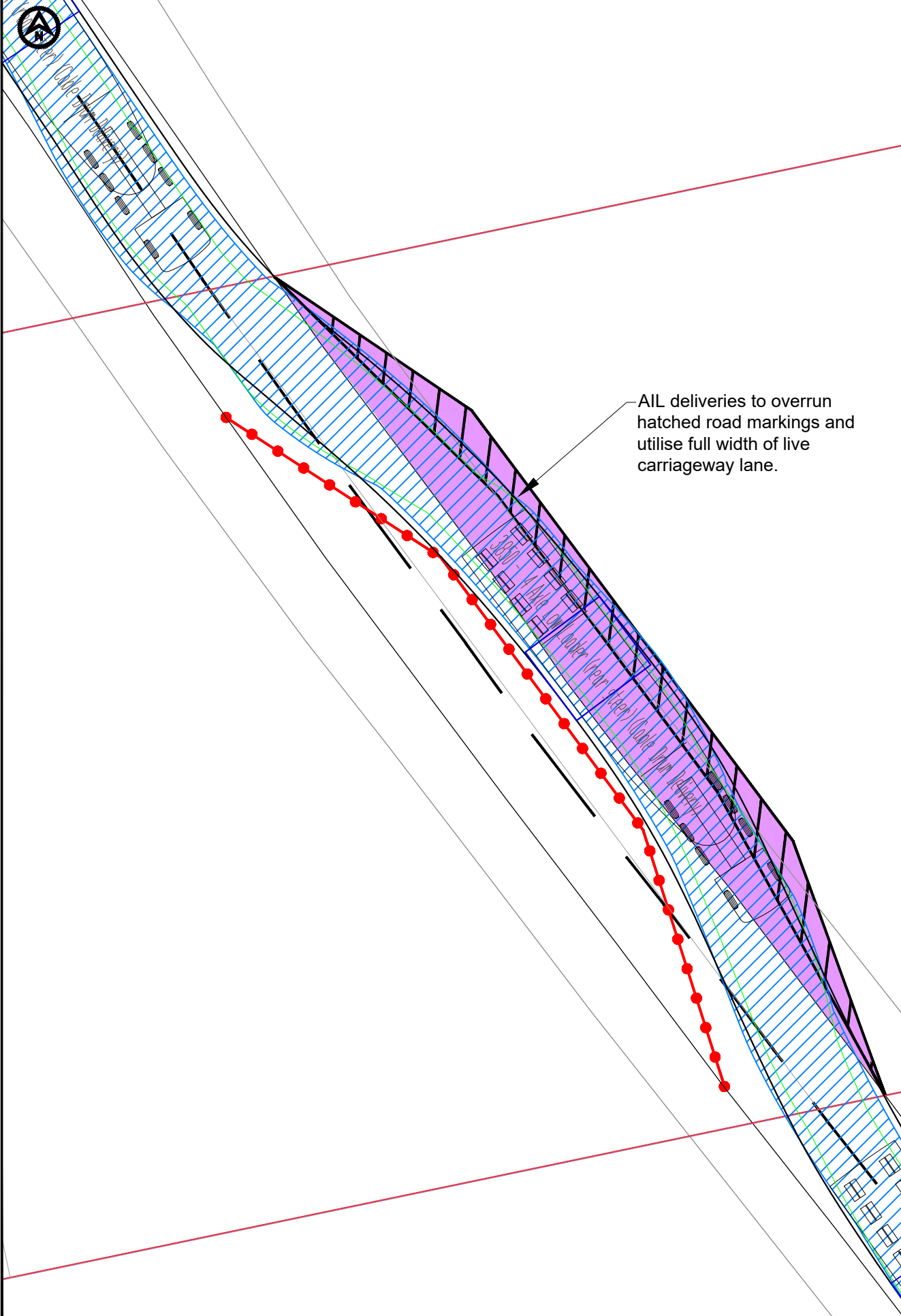

AIL deliveries to overrun hatched road markings and utilise full width of live carriageway lane.

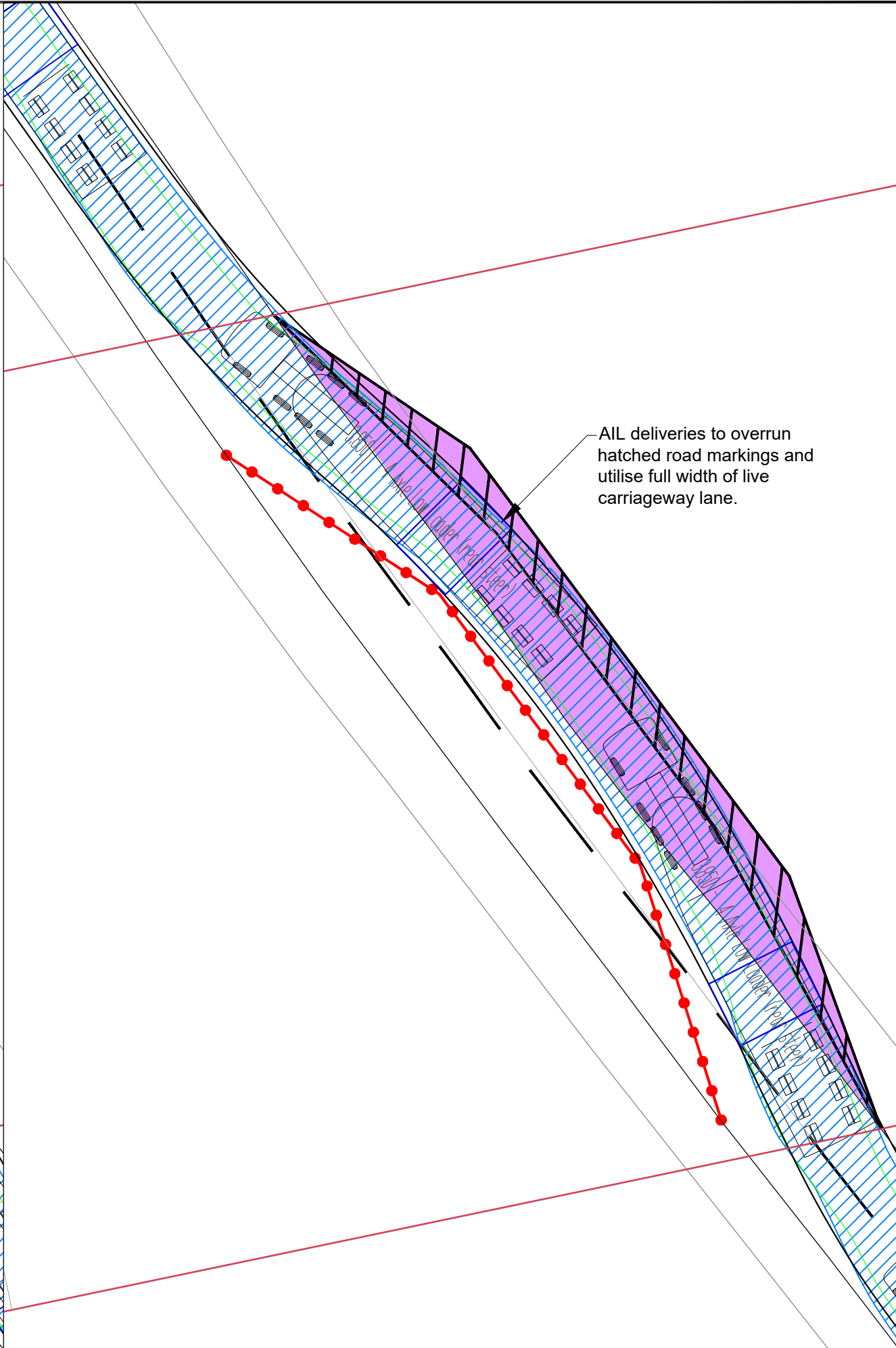

AIL deliveries to overrun hatched road markings and utilise full width of live carriageway lane.

- NOTES**
1. Do not scale from this drawing, all dimensions are in metres unless noted otherwise.
  2. This drawing has been based upon Ordnance Survey Maps and Royal Haskoning can not guarantee the accuracy of data.
  3. This drawing is an update to PB4476-DR034, first issued in the Norfolk Vanguard DCO application.
  4. Cable drum dimensions taken from Hornsea 3 Offshore Wind Farm document 'Main Construction Compound Access Strategy' September 2018.
  5. Typical AIL vehicle used suitable for cable drum loadings.

**KEY**

— ORDER LIMITS

**VEHICLE TRACKING**

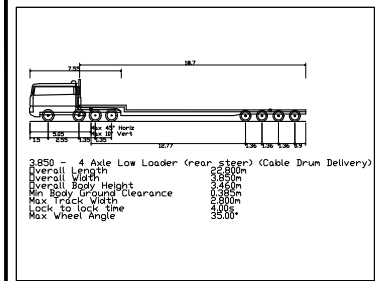

- VEHICLE BODY SWEPT PATH (FORWARD GEAR)
- VEHICLE CHASSIS SWEPT PATH
- INDICATIVE CABLE DRUM SWEPT PATH
- REQUIRED RESURFACING
- INDICATIVE CONES

**DRAFT - NOT FOR CONSTRUCTION**

F1.0	FIRST ISSUE			
REV	DATE	DESCRIPTION	BY	CHK APP

REVISIONS

CLIENT



PROJECT  
NORFOLK BOREAS OFFSHORE WIND FARM

TITLE  
B1149 TRAFFIC MANAGEMENT  
TYPICAL AIL CABLE DRUM  
DELIVERY  
SWEPT PATH ANALYSIS  
(NORTH EASTERN VERGE)



DRAWN	RNE	CHECKED	ADR	APPROVED	ADR
DATE	23.01.20	SCALE AT A3	1:250	CLIENTS REF.	
DRAWING No.	TP-PB5640-DR028				REVISION
CLIENT DWG No.					F1.0

## **13 APPENDIX 6 SCHEME OF HIGHWAY MITIGATION (B1145, CAWSTON)**

---



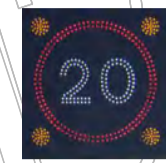

NEW VEHICULAR ACTIVATED SIGN (VAS) TO BE PROVIDED AT A LOCATION TO BE AGREED WITH NORFOLK COUNTY COUNCIL

20MPH ZONE SIGNS (DIAG 674, 675A)

20MPH ZONE (DIAG 674 AND 675A) & 'PEDESTRIANS IN ROAD AHEAD' (DIAG 544.1) SIGNS TO BE INTRODUCED WITH VILLAGE DESIGNED GATEWAY FEATURE.  
ROAD MARKINGS TO BE AGREED IN CONSULTATION WITH NCC

SEE DRAWING PB5640-DR016 FOR CAWSTON VILLAGE CENTRE INTERVENTION SCHEME

EXISTING LOCATION OF VEHICULAR ACTIVATED SIGN (VAS)



EXISTING LOCATION OF SCHOOL WARNING SIGN

EXISTING UNCONTROLLED PEDESTRIAN CROSSING TO BE IMPROVED

EXISTING 30MPH / NSL SPEED LIMIT AND VILLAGE SIGN TO BE REMOVED

NEW LOCATION FOR 20MPH ZONE SIGNS (DIAG 674 AND 675A) AND NSL SPEED LIMIT SIGN WITH NEW VILLAGE DESIGNED GATEWAY FEATURE INC 'PEDESTRIANS IN ROAD AHEAD' SIGN (DIAG 544.1).  
ROAD MARKINGS TO BE AGREED IN CONSULTATION WITH NCC

20MPH ZONE SIGNS (DIAG 674 AND 675A)

DRIVER AWARENESS WORKS ON B1145  
SCALE - 1:1000

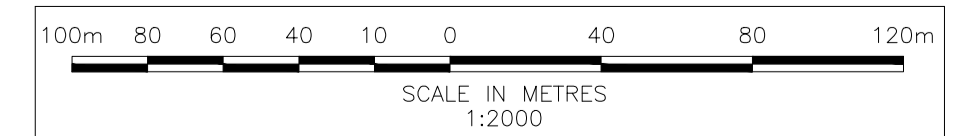

REPRODUCED FROM ORDNANCE SURVEY MAPS WITH PERMISSION FROM THE CONTROLLER OF HM STATIONERY OFFICE. CROWN COPYRIGHT RESERVED. LICENCE No. 100023422 2007.

- NOTES**
1. Do not scale from this drawing. All dimensions are in metres unless noted otherwise.
  2. This drawing has been based upon Ordnance Survey Maps and Royal Haskoning can not guarantee the accuracy of data.
  3. Access for pedestrians and cyclists is to be maintained at all times. accesses to properties are to be maintained and works programmed in consultation with property owners.
  4. Road markings and road signs are to be in accordance with the SI document "Traffic Signs Regulations and General Directions, 2016".
  5. For details of signs refer to 'Sign Schedule' drawing PB5640-DR020.

RNE/FEB/20	UPDATED TO SUIT STAGE 1 RSA	RNE	ADR	ADR
	FIRST ISSUE			
REV	DATE	DESCRIPTION	BY	CHK APP

REVISIONS

CLIENT



PROJECT  
NORFOLK BOREAS OFFSHORE WIND FARM

TITLE  
CAWSTON HIGHWAY INTERVENTION SCHEME  
APPROACH DRIVER AWARENESS WORKS ON B1145



DRAWN	RNE	CHECKED	ADR	APPROVED	ADR
DATE	03.01.2019	SCALE AT A1	1:2000	CLIENTS REF.	

DRAWING No. TP-PB5640-DR015  
CLIENT DWG No. F2.0





20MPH SPEED RESTRICTION  
SEE DRAWING PB5640-DR015  
TO CONFIRM THE FULL EXTENTS

INSTALL POST & 'ROAD NARROWS' SIGN (DIAG 516)  
AND ASSOCIATED 'VEHICLES IN THE MIDDLE OF  
THE ROAD' (DIAG 575) WITHIN VERGE.  
SIGNAGE TO BE KEPT CLEAR OF VEGETATION.  
INSTALL POST & 'NO WAITING' SIGN (DIAG 639-B)  
WITHIN VERGE.  
SIGNAGE TO BE KEPT CLEAR OF VEGETATION

EXTENT OF VERGE VEGETATION  
CLEARANCE/CUT BACK WITHIN  
HIGHWAY LAND AND VERGE.

ATTACH 'NO WAITING' SIGN (DIAG 639-A)  
TO EXISTING LAMP POST

INSTALL LOW LEVEL POST & 'NO  
WAITING' SIGN (DIAG 639-A) ADJACENT  
TO EXISTING BRICK WALL

EXTENT OF MARKED PARKING TO  
CATER FOR A MINIMUM OF 3  
VEHICLES (CAR)

EXTENT OF MARKED  
PARKING AREA TO CATER  
FOR A MINIMUM OF 6  
VEHICLES (CARS)

INSTALL LOW LEVEL POST & 'NO  
WAITING' SIGN (DIAG 639-A)  
ADJACENT EXISTING FENCE

ATTACH '20 MPH ZONE ENDS' SIGN (DIAG  
675A) TO EXISTING TRAFFIC SIGN POST.  
SIGNAGE TO BE KEPT CLEAR OF VEGETATION.

INSTALL POST & '20MPH ZONE' SIGN (DIAG 674) LOCATED  
NEXT TO RESIDENTIAL PROPERTY WALL AT THE BACK OF  
THE FOOTWAY UTILISING A CANTILEVERED RECTANGULAR  
BACKING BOARD THUS MAXIMISING AVAILABLE FOOTWAY  
WIDTH

INSTALL LOW LEVEL POST & 'NO WAITING'  
SIGN (DIAG 639-A) ADJACENT TO EXISTING  
TELEGRAPH POLE

INSTALL LOW LEVEL POST & 'NO  
WAITING' SIGN (DIAG 639-C)  
ADJACENT TO BRICK WALL

INSTALL 20MPH ZONE POST & 20MPH ZONE  
SIGNS (DIAG 674 AND 675A) BACK TO BACK.  
SIGNAGE TO BE KEPT CLEAR OF VEGETATION.

INSTALL LOW LEVEL POST & 'NO  
WAITING' SIGN (DIAG 639-A) ADJACENT  
TO BUILDING WALL

EXTENT OF MARKED  
PARKING TO CATER  
FOR 2 VEHICLES (CAR)

EXTENT OF MARKED  
PARKING TO CATER  
FOR 3 VEHICLES (CAR)

INSTALL LOW LEVEL POST & 'NO WAITING'  
SIGN ADJACENT TO BUILDING WALL

EXTENT OF VERGE VEGETATION  
CLEARANCE/CUT WHICH  
ENCROACHES ONTO HIGHWAY LAND.

ATTACH '20 MPH ZONE' SIGNS (DIAG 674) TO  
EXISTING TRAFFIC SIGN POSTS.  
SIGNAGE TO BE KEPT CLEAR OF VEGETATION.

INSTALL POST & '20MPH ZONE ENDS' SIGNS  
(DIAG 675A) WITHIN VERGE.  
SIGNAGE TO BE KEPT CLEAR OF VEGETATION

INSTALL POST & 'ROAD NARROWS' SIGN (DIAG  
516) AND ASSOCIATED 'VEHICLES IN THE  
MIDDLE OF THE ROAD' (DIAG 575) PEDESTRIANS  
IN ROAD AHEAD' SIGN (DIAG 544.1) WITHIN  
VERGE.  
SIGNAGE TO BE KEPT CLEAR OF VEGETATION.

EXTENT OF VERGE VEGETATION CLEARANCE/CUT BACK WITHIN  
HIGHWAY LAND AND VERGE.

ANY PROPOSED CUT BACK OF CAWSTON CONSERVATION AREA  
TREE CA6 TO BE DISCUSSED AND AGREED WITH BROADLAND  
DISTRICT COUNCIL IN ADVANCE OF WORKS

20MPH SPEED RESTRICTION  
SEE DRAWING PB5640-DR015 TO  
CONFIRM THE FULL EXTENTS



CAWSTON VILLAGE CENTRE - B1145  
SCALE - 1:500

REPRODUCED FROM ORDNANCE SURVEY MAPS WITH PERMISSION  
FROM THE CONTROLLER OF HM STATIONERY OFFICE. CROWN  
COPYRIGHT RESERVED. LICENCE No. 100023422 2007.

- NOTES**
- Do not scale from this drawing. All dimensions are in metres unless noted otherwise.
  - This drawing has been based upon Ordnance Survey Maps and Topographical Survey Information and Royal Haskoning can not guarantee the accuracy of data.
  - Services are to be protected in accordance with the requirements of the relevant statutory authorities.
  - Access for pedestrians and cyclists is to be maintained at all times. accesses to properties are to be maintained and works programmed in consultation with property owners.
  - Road markings and road signs are to be in accordance with the SI document 'Traffic Signs Regulations and General Directions, 2016'.
  - For details of signs refer to 'Sign Schedule' drawing PB5640-DR020.
  - All signs to be designed to minimum allowable sizes to fit into the conservation area of Cawston.
  - All proposed post and signs to be located to minimise street clutter, conservation impact and not to compromise footway widths.
  - HGV construction movements to be restricted to 9am to 3pm and 4pm to 6pm only.
  - All vegetation clearance and cutback to comply with Norfolk County Councils policy of grass cutting of visibility splays. Requiring a maintenance regime of five cuts between May and September in urban areas (defined as roads subject to less than a 40mph speed limit).

- GENERAL KEY**
- DESIGNATED PARKING BAY LINE MARKINGS (DIAG 1028)
  - SINGLE YELLOW LINE MARKINGS (50mm THICKNESS) (DIAG 1017)
  - SINGLE WHITE LINE MARKINGS (50mm THICKNESS) (DIAG 1026.1)
  - ROAD RESURFACING WORKS TO BE COMPLETED TO HIGH STREET INCLUDING IRONWORKS RAISING AND LEVELING IN AGREEMENT WITH NORFOLK COUNTY COUNCIL
  - REALIGNED ROAD MARKINGS
  - VEGETATION CLEARANCE / CUT BACK (SEE NOTE 10 FOR SCHEDULE OF TIMINGS)

**NOT FOR CONSTRUCTION**

REV	DATE	DESCRIPTION	BY	CHK	APP
RNE/FEB/20		UPDATED TO SUIT STAGE 1 RSA	RNE	ADR	ADR
		FIRST ISSUE			

REVISIONS

CLIENT



PROJECT  
**NORFOLK BOREAS  
OFFSHORE WIND FARM**

TITLE  
**CAWSTON HIGHWAY  
INTERVENTION SCHEME  
CAWSTON VILLAGE CENTRE**



DRAWN	RNE	CHECKED	ADR	APPROVED	ADR
DATE	03.01.2020	SCALE AT 1:500	CLIENTS REF.		
DRAWING No.	TP-PB5640-DR016				REVISION
CLIENT DWG No.					F2.0





CLEAR VISIBILITY (50M) TO BE PROVIDED AT ALL TIMES TO RESTRICT HGV TRAFFIC CONFLICTS

AVAILABLE VISIBILITY (2.4m x 87m)

CLEAR VISIBILITY TO MANUAL FOR STREET GUIDELINES FOR A 20MPH SPEED LIMIT (2.4m x 25m)

CLEAR VISIBILITY (50M) TO BE PROVIDED AT ALL TIMES TO RESTRICT HGV TRAFFIC CONFLICTS

CLEAR VISIBILITY (50M) TO BE PROVIDED AT ALL TIMES TO RESTRICT HGV TRAFFIC CONFLICT

- NOTES**
1. Do not scale from this drawing. All dimensions are in metres unless noted otherwise.
  2. This drawing has been based upon Ordnance Survey Maps and Royal Haskoning can not guarantee the accuracy of data.
  3. Access for pedestrians and cyclists is to be maintained at all times. Accesses to properties are to be maintained and works programmed in consultation with property owners.
  4. Road markings and road signs are to be in accordance with the SI document 'Traffic signs regulations and general directions, 2016'.
  5. Manual For Streets SSD for a 20mph speed limit is 25m.
  6. HGV construction movements to be restricted to 9am to 3pm and 4pm to 6pm only.
  7. All vegetation clearance and cutback to comply with Norfolk County Councils policy of grass cutting of visibility splays. Requiring a maintenance regime of five cuts between May and September in Urban areas (defined as roads subject to less than a 40mph speed limit).

- GENERAL KEY**
- DESIGNATED PARKING BAY LINE MARKINGS (DIAG 1028)
  - SINGLE YELLOW LINE MARKINGS (50mm THICKNESS) (DIAG 1017)
  - SINGLE WHITE LINE MARKINGS (50mm THICKNESS) (DIAG 1026.1)
- VISIBILITY KEY**
- JUNCTION VISIBILITY SPLAYS FOR A 20MPH SPEED LIMIT
  - AVAILABLE FORWARD VISIBILITY SPLAYS

**NOT FOR CONSTRUCTION**

RNE/FEB/20	UPDATED TO SUIT STAGE 1 RSA	RNE	ADR
REV	DATE	DESCRIPTION	BY
			CHK
			APP

REVISIONS

CLIENT



PROJECT  
NORFOLK BOREAS OFFSHORE WIND FARM

TITLE  
CAWSTON HIGHWAY INTERVENTION SCHEME  
HGV FORWARD VISIBILITY AND CHAPEL STREET JUNCTION VISIBILITY



DRAWN	RNE	CHECKED	ADR	APPROVED	ADR
DATE	03.01.2020	SCALE AT 1:500	CLIENTS REF.		
DRAWING No.	TP-PB5640-DR017			REVISION	
CLIENT DWG No.				F2.0	

**VISIBILITY ON THE B1145**  
SCALE - 1:500

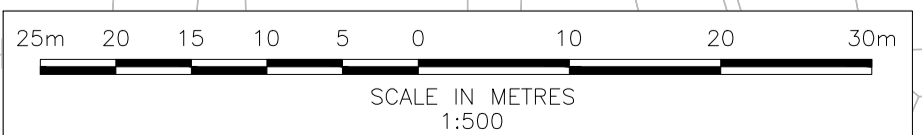

REPRODUCED FROM ORDNANCE SURVEY MAPS WITH PERMISSION FROM THE CONTROLLER OF HM STATIONERY OFFICE. CROWN COPYRIGHT RESERVED. LICENCE No. 100023422 2007.



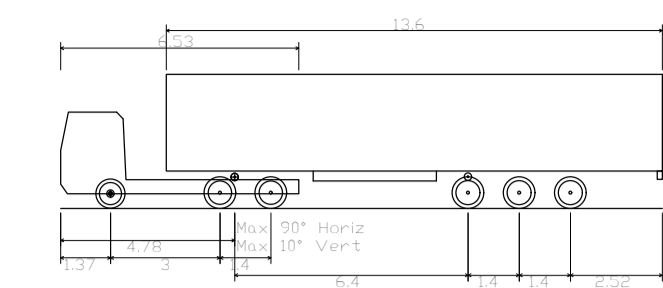

Max Legal Length (UK) Articulated Vehicle (16.5m)  
 Overall Length 16.500m  
 Overall Width 2.500m  
 Overall Body Height 3.650m  
 Min Body Ground Clearance 0.410m  
 Max Track Width 2.500m  
 Lock to lock time 5.00s  
 Kerb to Kerb Turning Radius 6.530m

- NOTES**
1. Do not scale from this drawing. All dimensions are in metres unless noted otherwise.
  2. This drawing has been based upon Ordnance Survey Maps and Royal Haskoning can not guarantee the accuracy of data.
  3. Access for pedestrians and cyclists is to be maintained at all times. Accesses to properties are to be maintained and works programmed in consultation with property owners.
  4. Road markings and road signs are to be in accordance with the si document "Traffic signs regulations and general directions, 2016".
  5. HGV construction movements to be restricted to 9am to 3pm and 4pm to 6pm only.

**KEY**

- VEHICLE BODY SWEEP PATH (FORWARD GEAR)
- VEHICLE CHASSIS SWEEP PATH

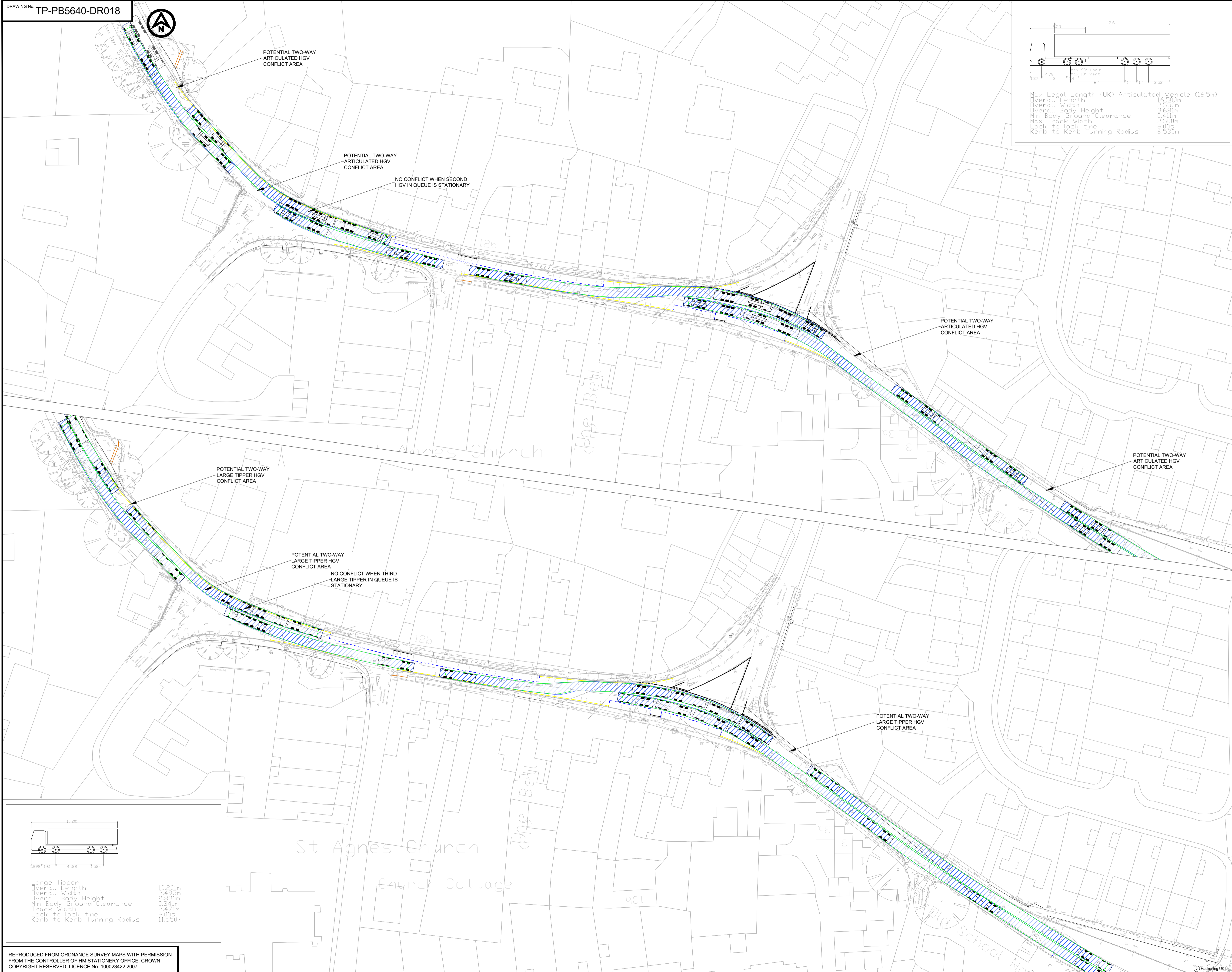

**NOT FOR CONSTRUCTION**

RNE/FEB/20	UPDATED TO SUIT STAGE 1 RSA	RNE	ADR	ADR
REV	DATE	DESCRIPTION	BY	CHK
				APP

REVISIONS

CLIENT



PROJECT  
 NORFOLK BOREAS  
 OFFSHORE WIND FARM

TITLE  
 CAWSTON HIGHWAY  
 INTERVENTION SCHEME  
 SWEEP PATH ANALYSIS  
 ARTICULATED AND LARGE TIPPER  
 VEHICLES - TWO WAY MOVEMENTS



DRAWN	RNE	CHECKED	ADR	APPROVED	ADR
DATE	03.01.2020	SCALE AT A1	1:500	CLIENTS REF.	
DRAWING No.	TP-PB5640-DR018	REVISION			
CLIENT DWG No.					F2.0

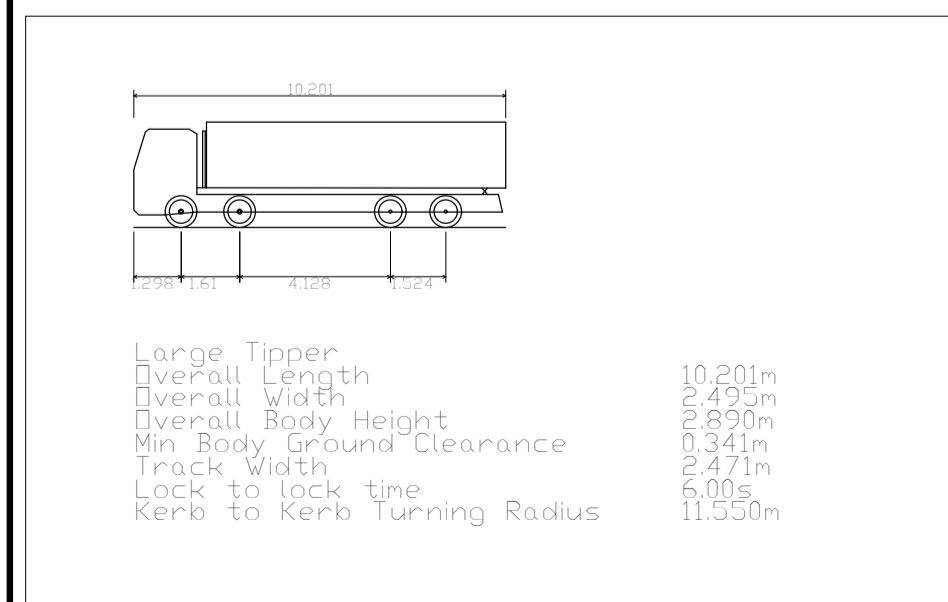

Large Tipper  
 Overall Length 10.201m  
 Overall Width 2.495m  
 Overall Body Height 2.890m  
 Min Body Ground Clearance 0.341m  
 Track Width 2.471m  
 Lock to lock time 5.00s  
 Kerb to Kerb Turning Radius 11.550m



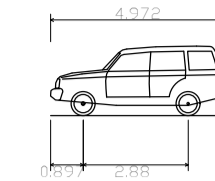

Luxury 4x4 (2006)  
 Overall Length 4.972m  
 Overall Width 2.034m  
 Overall Body Height 1.905m  
 Min Body Ground Clearance 0.279m  
 Max Track Width 1.884m  
 Lock to lock time 4.00s  
 Kerb to Kerb Turning Radius 5.800m

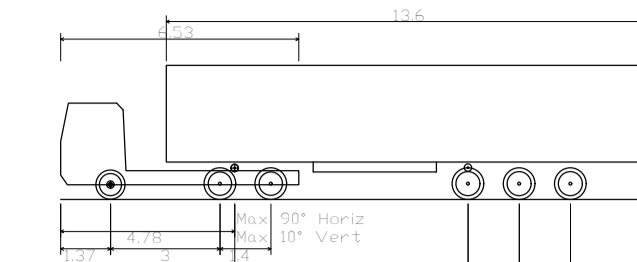

Max Legal Length (UK) Articulated Vehicle (16.5m)  
 Overall Length 16.500m  
 Overall Width 2.500m  
 Overall Body Height 3.650m  
 Min Body Ground Clearance 0.411m  
 Max Track Width 2.500m  
 Lock to lock time 5.00s  
 Kerb to Kerb Turning Radius 6.530m

- NOTES**
1. Do not scale from this drawing. All dimensions are in metres unless noted otherwise.
  2. This drawing has been based upon Ordnance Survey Maps and Royal Haskoning can not guarantee the accuracy of data.
  3. Access for pedestrians and cyclists is to be maintained at all times. Accesses to properties are to be maintained and works programmed in consultation with property owners.
  4. Road markings and road signs are to be in accordance with the si document 'Traffic signs regulations and general directions, 2016'.
  5. HGV construction movements to be restricted to 9am to 3pm and 4pm to 6pm only.

**KEY**

VEHICLE BODY SWEEP PATH (FORWARD GEAR)

VEHICLE CHASSIS SWEEP PATH



**NOT FOR CONSTRUCTION**

RNE/FEB/20	UPDATED TO SUIT STAGE 1 RSA	RNE	ADR	ADR
REV	DATE	DESCRIPTION	BY	CHK
				APP

REVISIONS

CLIENT



PROJECT  
 NORFOLK BOREAS  
 OFFSHORE WIND FARM

TITLE  
 CAWSTON HIGHWAY  
 INTERVENTION SCHEME  
 SWEEP PATH ANALYSIS  
 ARTICULATED, LARGE TIPPER  
 VEHICLES AND CAR - TWO WAY  
 MOVEMENTS



DRAWN	RNE	CHECKED	ADR	APPROVED	ADR
DATE	03.01.2020	SCALE AT A1	1:500	CLIENTS REF.	

DRAWING No.	TP-PB5640-DR019	REVISION	
CLIENT DWG No.			F2.0

Large Tipper  
 Overall Length 10.201m  
 Overall Width 2.495m  
 Overall Body Height 2.890m  
 Min Body Ground Clearance 0.341m  
 Track Width 2.471m  
 Lock to lock time 5.00s  
 Kerb to Kerb Turning Radius 11.550m

Luxury 4x4 (2006)  
 Overall Length 4.972m  
 Overall Width 2.034m  
 Overall Body Height 1.905m  
 Min Body Ground Clearance 0.279m  
 Max Track Width 1.884m  
 Lock to lock time 4.00s  
 Kerb to Kerb Turning Radius 5.800m





Diagram: 674  
 Width: 615mm  
 Height: 925mm  
 x-height: (Cawston = 37.5mm)  
 Area: 0.57m<sup>2</sup>  
 Material: RA2 (BS EN 12899)



Diagram: 675A  
 Width: 600mm  
 Height: 855mm  
 x-height: n/a  
 Area: 0.51m<sup>2</sup>  
 Material: RA2 (BS EN 12899)



Diagram: 516  
 Width: 600mm  
 Height: 550mm  
 x-height: n/a  
 Area: 0.33m<sup>2</sup>  
 Material: RA2 (BS EN 12899)

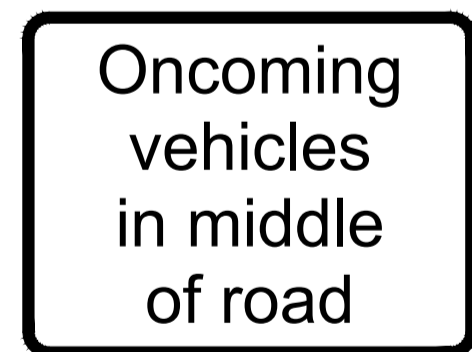

Diagram: 575  
 Width: 600mm  
 Height: 450mm  
 x-height: 62.5mm  
 Area: 0.27m<sup>2</sup>  
 Material: RA2 (BS EN 12899)



Diagram: 544.1  
 Width: 600mm  
 Height: 550mm  
 x-height: n/a  
 Area: 0.33m<sup>2</sup>  
 Material: RA2 (BS EN 12899)



Diagram: 639-A  
 Width: 135mm  
 Height: 100mm  
 x-height: 15mm  
 Area: 0.02m<sup>2</sup>  
 Material: RA2 (BS EN 12899)



Diagram: 639-B  
 Width: 135mm  
 Height: 190mm  
 x-height: 15mm  
 Area: 0.03m<sup>2</sup>  
 Material: RA2 (BS EN 12899)



Diagram: 639-C  
 Width: 135mm  
 Height: 190mm  
 x-height: 15mm  
 Area: 0.03m<sup>2</sup>  
 Material: RA2 (BS EN 12899)

**NOTES**  
 1. Do not scale from this drawing, all dimensions are in metres unless noted otherwise.  
 2. This drawing has been based upon Ordnance Survey Maps and Royal Haskoning can not guarantee the accuracy of data.  
 3. Access for pedestrians and cyclists is to be maintained at all times, accesses to properties are to be maintained and works programmed in consultation with property owners.  
 4. Road markings and road signs are to be in accordance with the si document "traffic signs regulations and general directions, 2016".

**KEY**

**NOT FOR CONSTRUCTION**

RNE	FEB20	UPDATED TO SUIT STAGE 1 RSA	RNE	ADR	ADR
REV	DATE	DESCRIPTION	BY	CHK	APP

**REVISIONS**

**CLIENT**



**PROJECT**  
 NORFOLK BOREAS  
 OFFSHORE WIND FARM

**TITLE**  
 CAWSTON HIGHWAY  
 INTERVENTION SCHEME  
 SIGN SCHEDULES



DRAWN	RNE	CHECKED	ADR	APPROVED	ADR
DATE	03.01.2020	SCALE AT A1	1:500	CLIENTS REF.	
DRAWING No.	TP-PB5640-DR020			REVISION	
CLIENT DWG No.				F2.0	

## **14 APPENDIX 7 SCHEME OF HIGHWAY MITIGATION (THE STREET, OULTON)**

---

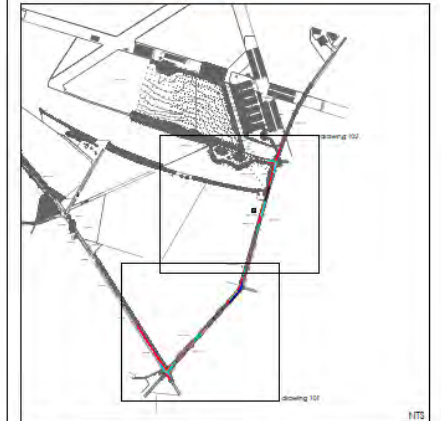

### OPTION 1: PASSING PLACES

#### GENERAL NOTES:

- PASSING PLACES (PP) TO BE FORMED BY SHALLOW-DIG CELLULAR SYSTEM (E.G. GRASSCRETE, OR SIMILAR) PROVIDING LOCALISED 6.0m OVERALL ROAD WIDTH, WITH PERMEABLE DRAINAGE TO SUB-STRATA. PASSING PLACES ARE LOCATED AND SPECIFIED WITH SHALLOW-DIG CELLULAR SYSTEM SO TO MINIMISE IMPACT OF THEIR CONSTRUCTION ON EXISTING TREE ROOT PROTECTION AREAS.
- THE DRAWING IS BASED ON A TOPOGRAPHIC SURVEY UNDERTAKEN BY PLANDISCL REF 17/697 IN CONJUNCTION WITH DIGITAL OS MAPPING.
- ANY EXCAVATION CLOSE TO TREES/HEDGES TO BE CARRIED OUT IN ACCORDANCE WITH NLAG GUIDELINES.
- SERVICES ARE TO BE PROTECTED IN ACCORDANCE WITH THE REQUIREMENTS OF THE RELEVANT STATUTORY AUTHORITIES.
- TO BE READ IN CONJUNCTION WITH ALL OTHER LAYOUT AND DETAIL DRAWINGS.
- ACCESS FOR PEDESTRIANS AND CYCLISTS IS TO BE MAINTAINED AT ALL TIMES. ACCESSES TO PROPERTIES ARE TO BE MAINTAINED AND WORKS PROGRAMMED IN CONSULTATION WITH PROPERTY OWNERS.
- ANY ROAD MARKINGS/ROAD SIGNS ARE TO BE IN ACCORDANCE WITH THE SI DOCUMENT TRAFFIC SIGNS REGULATIONS AND GENERAL DIRECTIONS, 2016.

© Crown Copyright 2018. All rights reserved. Licence number 100022432

Create Consulting Engineers accept no responsibility for any unauthorised amendments to this drawing. Only figured dimensions are to be worked to. **COPYRIGHT © RESERVED**

REV	DATE	AMENDMENT DETAILS	DRAWN	APPROVED
A	15.11.18	ROADS WIDENING ON THE BEND	REC	PP
Telephone: 01603 877010				

PROJECT: HORNSEA 3 OFF-SHORE WIND FARM		DATE: 18.09.18	DRAWING STATUS: INFORMATION	
DRAWING TITLE: PROPOSED IMPROVEMENTS THE STREET, OULTON (OPTION 1) SHEET 1 OF 2		SCALE: 1:1,000	DESIGNED: JMDA	DRAWN: JMDA
JOB NO: 1554		CHECKED: P2	APPROVED: P2	
CLIENT: ORSTED	DRAWING NO: 03/101	REVISION: A		

www.createconsultingengineers.co.uk

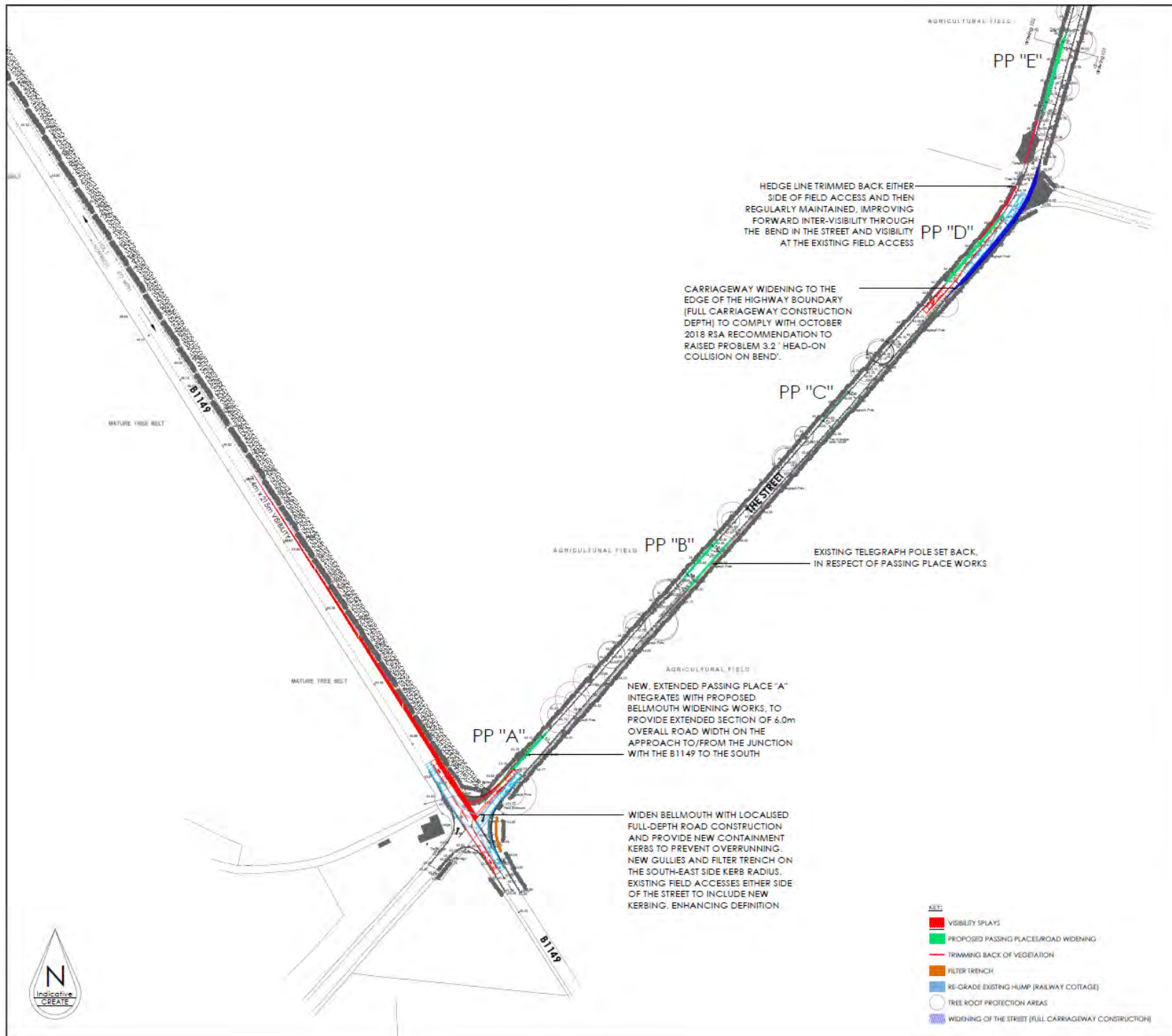



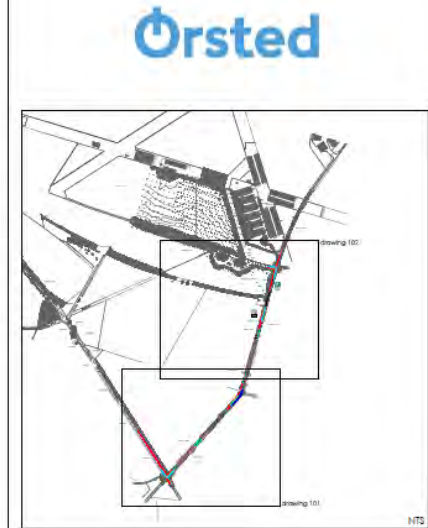
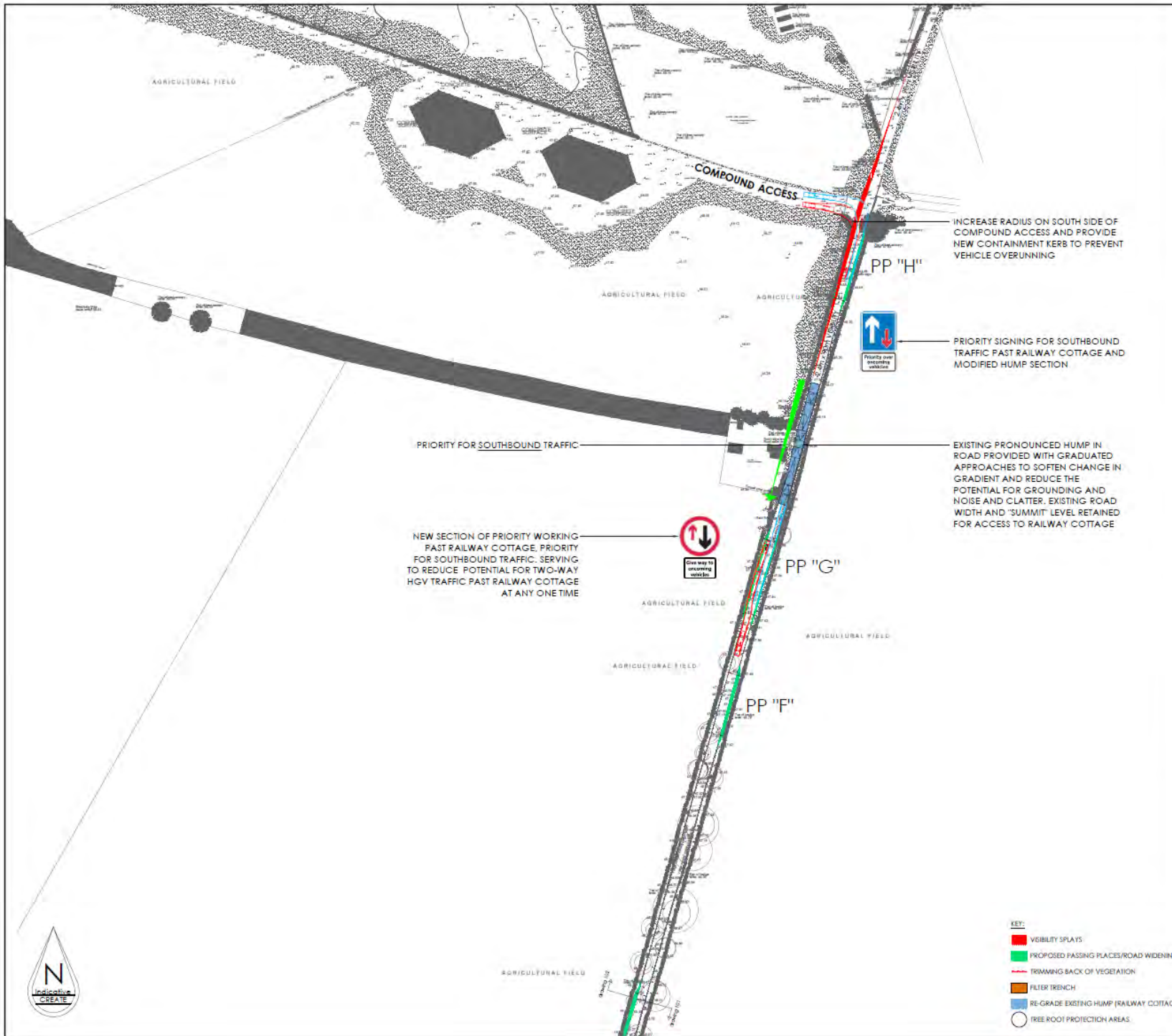

### OPTION 1: PASSING PLACES

- GENERAL NOTES:**
- PASSING PLACES (PP) TO BE FORMED BY SHALLOW-DIG CELLULAR SYSTEM (E.G. GRASSCRETE OR SIMILAR) PROVIDING LOCALISED 40m OVERALL ROAD WIDTH, WITH PERMEABLE DRAINAGE TO SUB-STRATA. PASSING PLACES ARE LOCATED AND SPECIFIED WITH SHALLOW-DIG CELLULAR SYSTEM SO TO MINIMISE IMPACT OF THEIR CONSTRUCTION ON EXISTING TREE ROOT PROTECTION AREAS.
  - THE DRAWING IS BASED ON A TOPOGRAPHIC SURVEY UNDERTAKEN BY PLANESCIL REF 17497 IN CONJUNCTION WITH DIGITAL OS MAPPING.
  - ANY EXCAVATION CLOSE TO TREES/HEDGES TO BE CARRIED OUT IN ACCORDANCE WITH HJHG GUIDELINES.
  - SERVICES ARE TO BE PROTECTED IN ACCORDANCE WITH THE REQUIREMENTS OF THE RELEVANT STATUTORY AUTHORITIES.
  - TO BE READ IN CONJUNCTION WITH ALL OTHER LAYOUT AND DETAIL DRAWINGS.
  - ACCESS FOR PEDESTRIANS AND CYCLISTS IS TO BE MAINTAINED AT ALL TIMES. ACCESS TO PROPERTIES ARE TO BE MAINTAINED AND WORKS PROGRAMMED IN CONSULTATION WITH PROPERTY OWNERS.
  - ANY ROAD MARKINGS/ROAD SIGNS ARE TO BE IN ACCORDANCE WITH THE SI DOCUMENT "TRAFFIC SIGNS REGULATIONS AND GENERAL DIRECTIONS, 2016"
- © Crown Copyright 2018. All rights reserved. Licence number 100022432

Create Consulting Engineers accept no responsibility for any unauthorised amendments to this drawing. Only figured dimensions are to be worked to. COPYRIGHT © RESERVED



NO.	15.11.18	ROAD WORKING ON THE BEND	IC	PZ
REV.	DATE	AMENDMENT DETAILS	DRAWN	APPROVED

Telephone: 01603 872010 01603 872010 045 409 4520

PROJECT HORNSEA 3 OFF-SHORE WIND FARM	DATE 18.09.18	DRAWING STATUS INFORMATION	
DRAWING TITLE PROPOSED IMPROVEMENTS THE STREET, OUTLIN (OPTION 1) SHEET 2 OF 2	SCALE 1:1,000	DESIGNED MDA	
CHECKED PZ	DRAWN PZ	APPROVED PZ	create CONSULTING ENGINEERS LTD
JOB No 1554	DRAWING No 03/102	REVISION A	

www.createconsultingengineers.co.uk

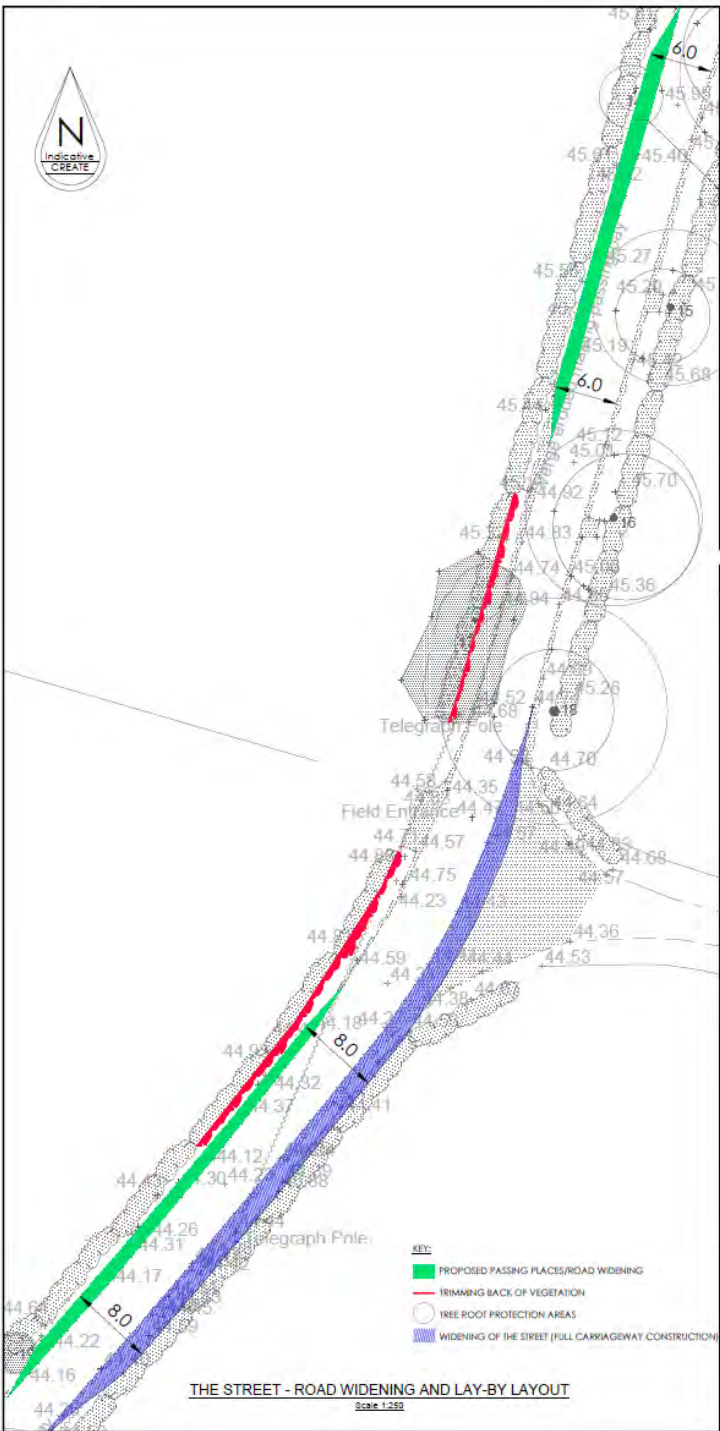
DO NOT SCALE ORIGINAL SHEET SITE-A1 LANDSCOPE



THE STREET - ROAD WIDENING AND LAY-BY LAYOUT  
Scale 1:250

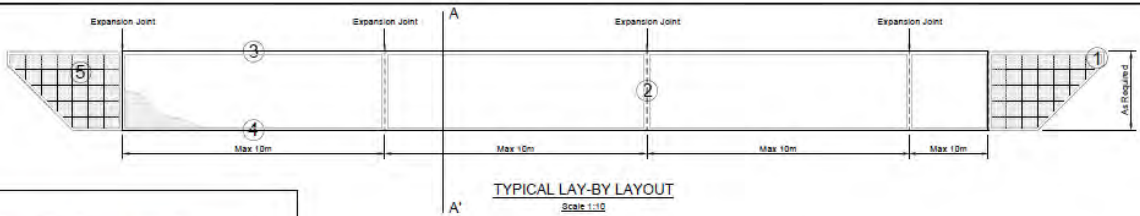

TYPICAL LAY-BY LAYOUT  
Scale 1:10



TYPICAL GRASSCRETE PAVING AFTER INSTALLATION

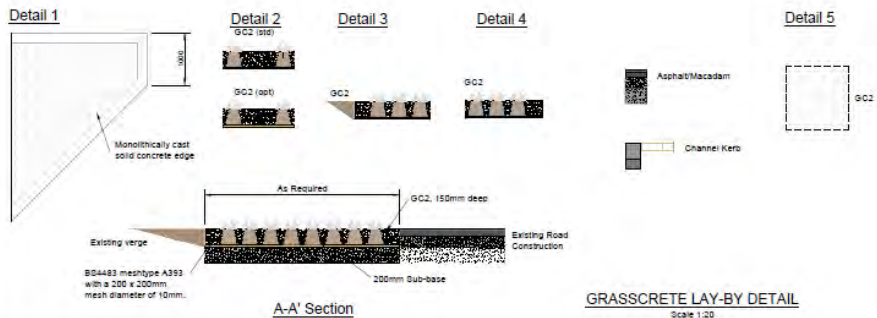

GRASSCRETE LAY-BY DETAIL  
Scale 1:20

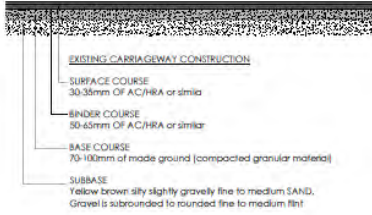

THE STREET EXISTING CONSTRUCTION DETAIL  
Not to Scale

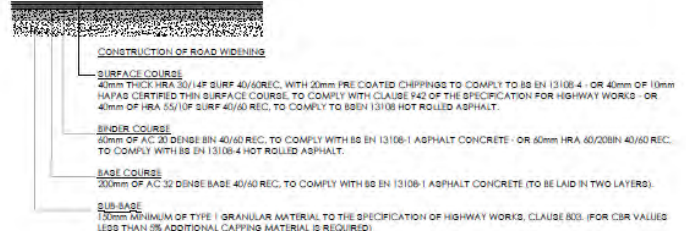

THE STREET ROAD WIDENING CONSTRUCTION DETAIL  
Not to Scale

NOTE: EXISTING ROAD CONSTRUCTION OBTAINED FROM PAVEMENT ASSESSMENT UNDERTAKEN BY AF HOWLAND ASSOCIATES ON THE 26TH NOVEMBER 2018. FOUR ROAD CORING TESTS UNDERTAKEN ALONG THE STREET, CBR01 AND CBR04 FROM THE ASSESSMENT UNDERTAKEN WITHIN CARRIAGEWAY AND THE RESULTS WERE USED TO DETERMINE THE ROAD CONSTRUCTION OF THE STREET.

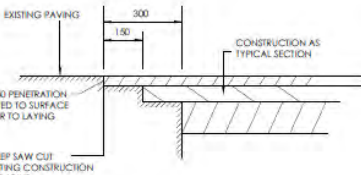

TYPICAL DETAIL TIE-IN BETWEEN NEW & EXISTING BITUMINOUS CONSTRUCTION  
SCALE 1:10



© Crown Copyright 2018. All rights reserved. Licence number 100022432

Create Consulting Engineers accept no responsibility for any unauthorised amendments to this drawing. Only figured dimensions are to be worked to. [COPYRIGHT © RESERVED]

GENERAL NOTES:

- GC2 GRASSCRETE IS RECOMMENDED FOR A 30-40 TONNE VEHICLE LOADING. HOWEVER, THIS IS AN INDICATION WHEN THE LOAD IS BASED ON TYPICAL NUMBER OF TYRES FOR VEHICLE TYPE, MULTIPLIED BY THE PERMISSIBLE POINT LOAD. FOR HEAVY GOODS VEHICLES THIS WILL NORMALLY FEATURE 10 TYRES BEING USED TO ACHIEVE A 40.0 TONNE CAPABILITY, HOWEVER FOR ABNORMAL LOADS WITH MULTIPLE AXLES THIS HAS BEEN GRASSCRETE BEING USED FOR VEHICLES UP TO 220 TONNES GROSS VEHICLE WEIGHT.
- THE DRAWING IS BASED ON A TOPOGRAPHIC SURVEY UNDERTAKEN BY PLANDESIGN REF 17697 IN CONJUNCTION WITH DIGITAL OS MAPPING.
- ANY EXCAVATION CLOSE TO TREES/HEDGES TO BE CARRIED OUT IN ACCORDANCE WITH N.J.L.G GUIDELINES.
- SERVICES ARE TO BE PROTECTED IN ACCORDANCE WITH THE REQUIREMENTS OF THE RELEVANT STATUTORY AUTHORITIES.
- TO BE READ IN CONJUNCTION WITH ALL OTHER LAYOUT AND DETAIL DRAWINGS.
- ANY ROAD MARKINGS/ROAD SIGNS ARE TO BE IN ACCORDANCE WITH THE SI DOCUMENT 'TRAFFIC SIGNS REGULATIONS AND GENERAL DIRECTIONS, 2014'

REV	DATE	AMENDMENT DETAILS	DRAWN	APPROVED

Telephone: 01603 877010

PROJECT INFORMATION	DATE	DRAWING STATE
HORNSEA 3 OFF-SHORE WIND FARM	16.11.18	INFORMATION
DRAWN BY: PROPOSED IMPROVEMENTS THE STREET, CULION, CONSTRUCTION DETAILS	AS SHOWN	EC EC
CHECKED BY: 1554	PIZ	APPROVED PZ
CLIENT: ORSTED	DRAWING NO: 03/110	REVISION

www.createconsultingengineers.co.uk

DO NOT SCALE ORIGINAL SHEET SIZE: A1 Landscape



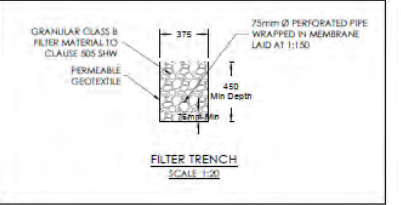
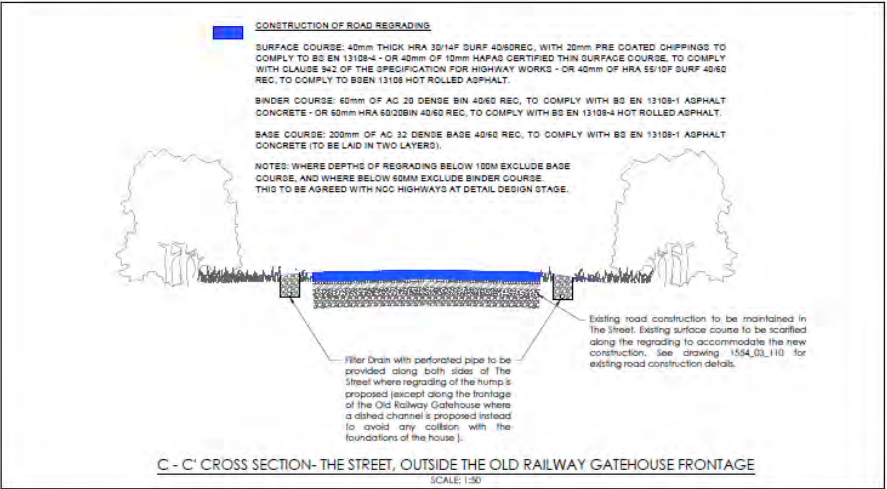
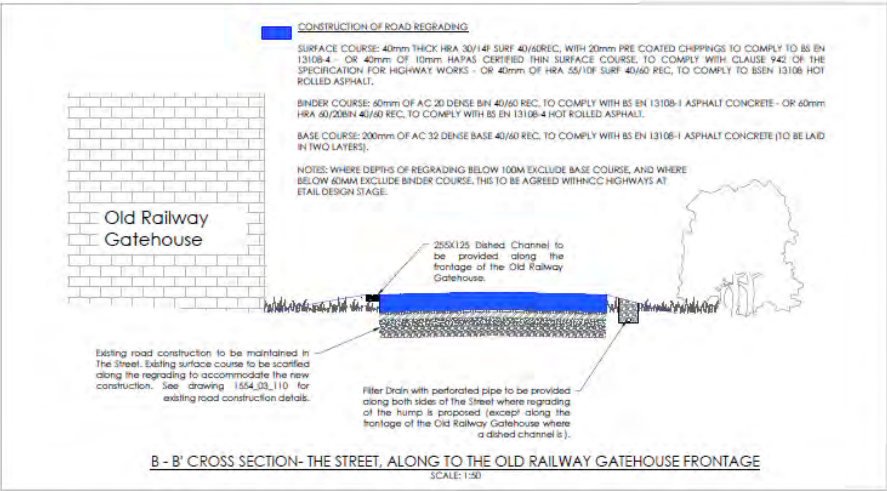
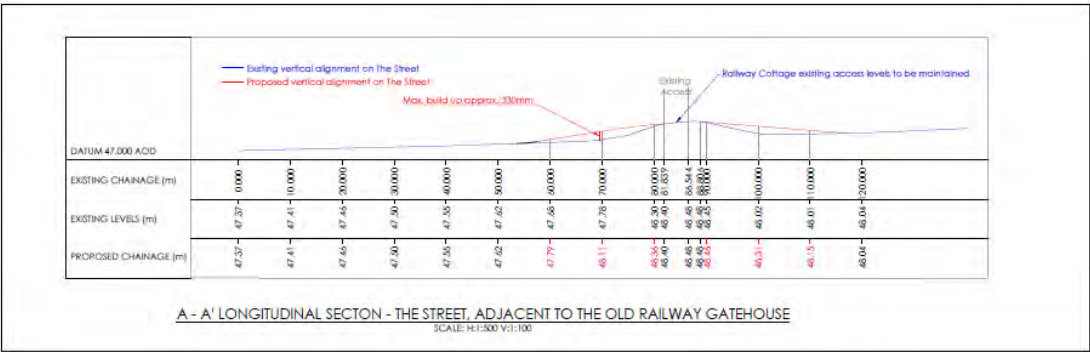
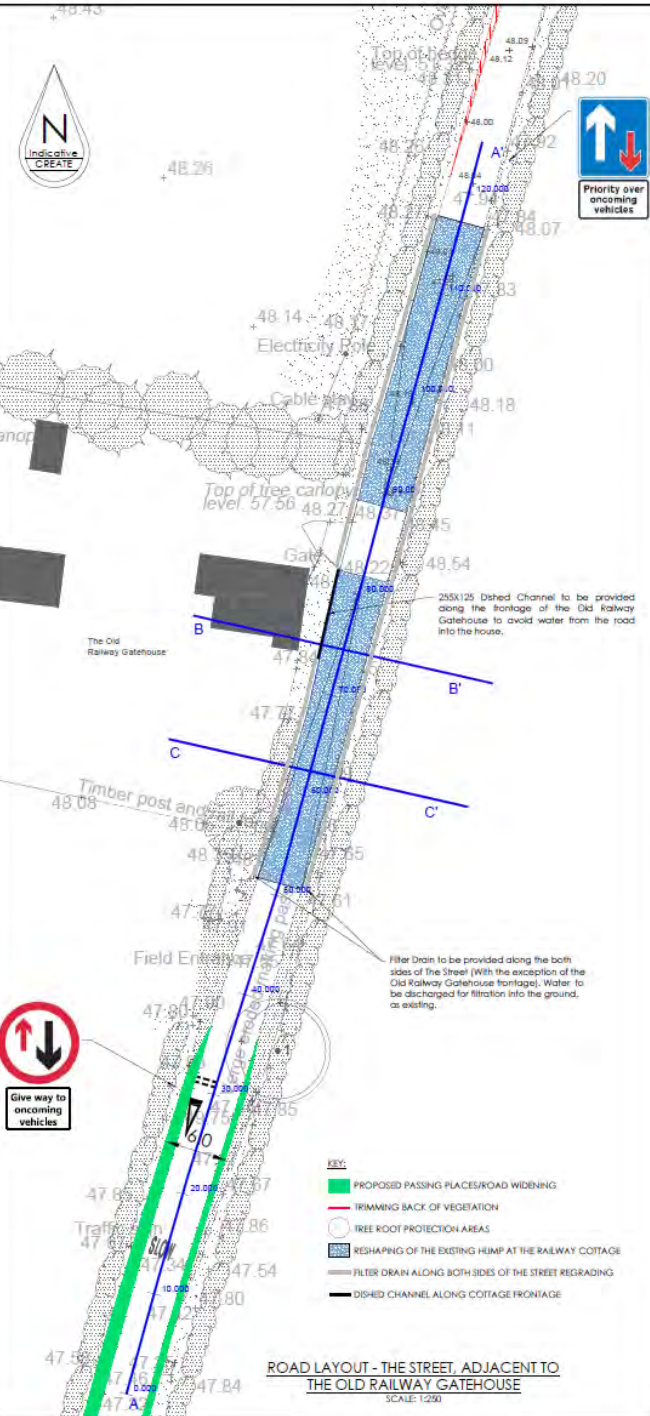

© Crown Copyright 2018. All rights reserved. Licence number 100022432

Create Consulting Engineers accept no responsibility for any unauthorised amendments to this drawing. Only figured dimensions are to be worked to. COPYRIGHT © RESERVED.

**GENERAL NOTES:**

1. THE DRAWING IS BASED ON A TOPOGRAPHIC SURVEY UNDERTAKEN BY FLANDESCCL REF 17697 IN CONJUNCTION WITH DIGITAL OS MAPPING.
2. ANY EXCAVATION CLOSE TO TREES/HEDGES TO BE CARRIED OUT IN ACCORDANCE WITH N3/0 GUIDELINES.
3. SERVICES ARE TO BE PROTECTED IN ACCORDANCE WITH THE REQUIREMENTS OF THE RELEVANT STATUTORY AUTHORITIES.
4. TO BE READ IN CONJUNCTION WITH ALL OTHER LAYOUT AND DETAIL DRAWINGS.
5. ACCESS FOR PEDESTRIANS AND CYCLISTS IS TO BE MAINTAINED AT ALL TIMES. ACCESS TO PROPERTIES ARE TO BE MAINTAINED AND WORKS PROGRAMMED IN CONSULTATION WITH PROPERTY OWNERS.
6. ANY ROAD MARKINGS/ROAD SIGNS ARE TO BE IN ACCORDANCE WITH THE SI DOCUMENT TRAFFIC SIGNS REGULATIONS AND GENERAL DIRECTIONS, 2016.

REV	DATE	AMENDMENT DETAILS	DRAWN	APPROVED

Telephone: 01603 877010

PROJECT HORNSEA 3 OFF-SHORE WIND FARM	DATE 22.11.18	DRAWING STATUS SCHEMATIC	INFORMATION DESIGNED DRAWN CHECKED APPROVED	
DRAWING TITLE PROPOSED ROAD REGRADING OLD RAILWAY GATEHOUSE THE STREET, OULTON	DRAWING No. 1554	REVISED		

www.createconsultingengineers.co.uk